

Digitalización de la Industria con nuevas Tendencias Tecnológicas (HDBaseT)

Neyton Avila – Consultant TSE (México – D2)

(MIA) Maestría en Informática Aplicada

Ingeniero en Telemática

CCNPX3 (Enterprise, Data Center, Security)

Erick Carmona– Consultant TSE (México – D1)

Ingeniero en Control y Automatización

PANDUIT™



Presentación

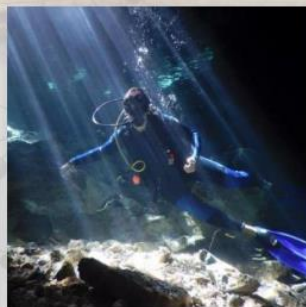

Erick Carmona

Technical Systems Engineer
30 | Estado de México

Ing. en Control y Automatización
Esp. Control Avanzado
Instituto Politécnico Nacional

PRESENTACIÓN



JORGE NEYTON

34 | Tepic, Nayarit. MX

Maestría en **Informática Aplicada**
Ingeniero en Telemática

Cisco CCNP Certifications
Enterprise, Data Center, Security,
Business Development
Digital Transformation

Mobile: +52 33 16068159
neyton.avila@panduit.com



About Us

PANDUIT + ATLONA: THE NEW LEADER IN AV SOLUTIONS

Atlona is proud to announce it is now a **Panduit** company, a leading global provider of network infrastructure solutions. The combination of Panduit's cabling and connectivity products and Atlona's wide range of AV solutions supports the growing adoption of AV over IP systems. Now, you can trust one company to provide an end-to-end AV solution for your conference rooms, training rooms, boardrooms, classrooms, and digital signage.



GET TO
KNOW
PANDUIT

#OnePanduit #ConPanduitTodosConectados
#AccelerateThePossible #PanduitLatam

GET TO
KNOW
PANDUIT

Atlona CEO

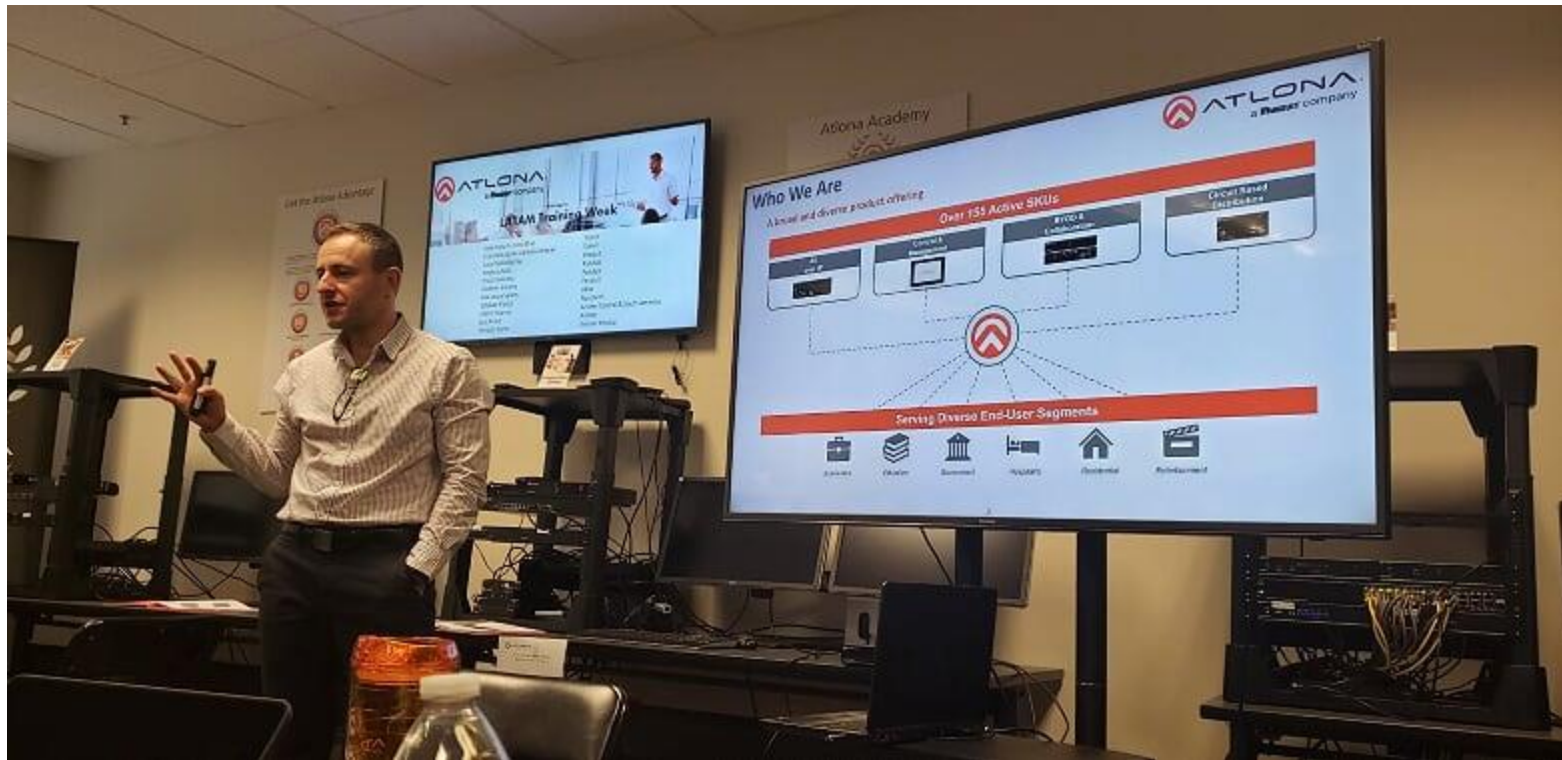

Atlona Testing LAB - HQ



Atlona Testing LAB - HQ

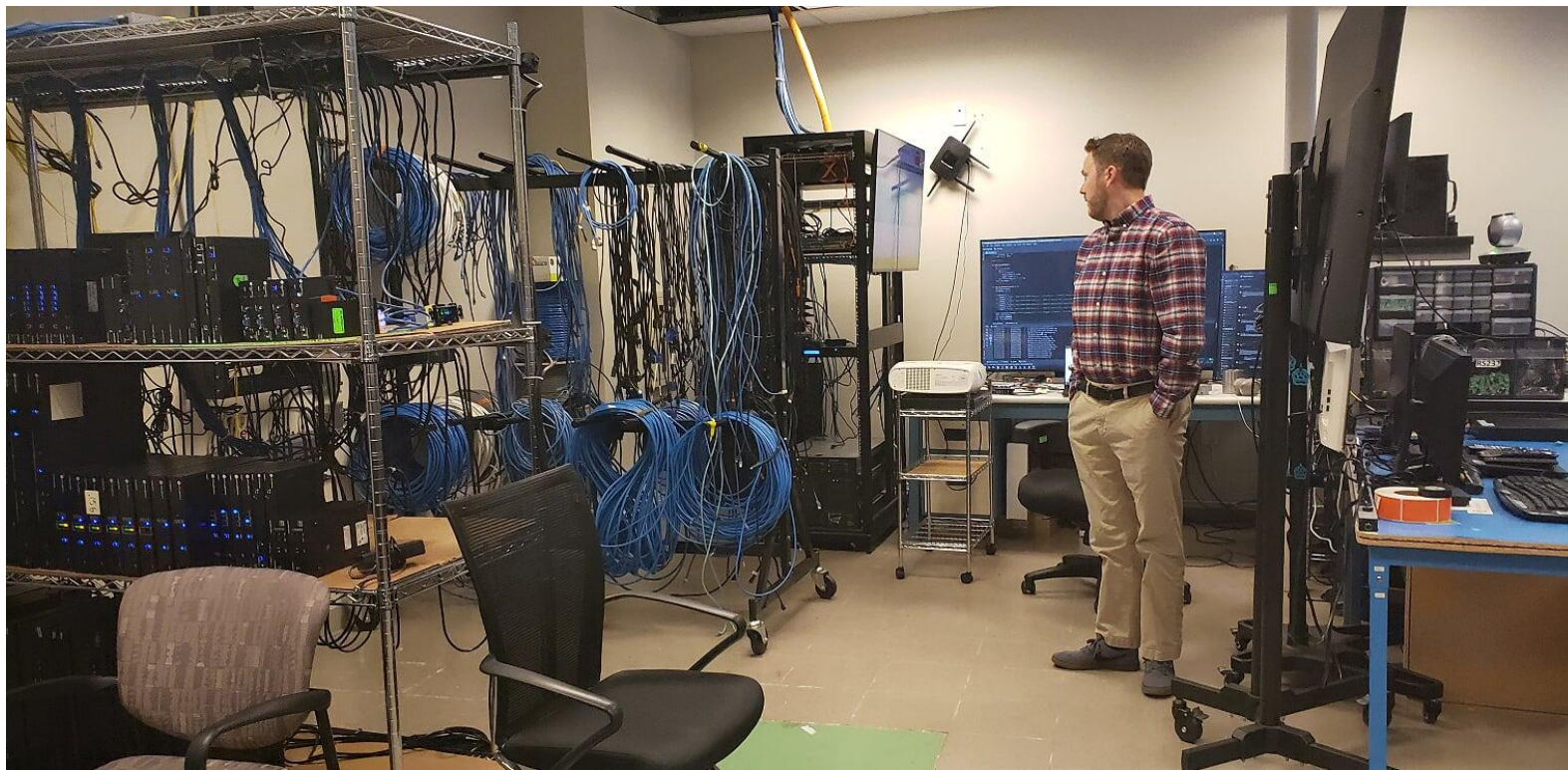

Personal Pod for Certification – ATLONA HQ



Atlona HQ Training (San José, CA)



LATAM Team



Infrastructure for a Connected World



PANDUIT®



Catálogo Digital de Entrenamientos 2020 Panduit



GET TO KNOW PANDUIT

Descargue aquí las presentaciones PDF, de los entrenamientos más actuales de Panduit



Wi-Fi 6 y 5G para Negocios Empresariales

► Presentación PDF



Smart Cities, transformación digital

► Presentación PDF



Evolución Tecnológica: TIA 1179

► Presentación PDF



Estándares aplicados a Ethernet Industrial

► Presentación PDF



Infraestructura en Hiperconvergencia

► Presentación PDF



MICE, Estrategia de Zonificación

► Presentación PDF



Cybersecurity, la seguridad del mañana

► Presentación PDF



Mejore sus KPIs en el Piso de Planta

► Presentación PDF



Wi-Fi 6 y 5G para Negocios Empresariales
Video



Cybersecurity: la seguridad del mañana
Video



MICE Estrategia de Zonificación



TIA 1179: Infraestructura de red en Hospitales
Video



Smart Cities, transformación digital
Video



Implemente y mejore sus KPIs en el Piso de Planta al Monitorar la Infraestructura Física



Infraestructura Física en Hiperconvergencia
Video



Estándares aplicados a Ethernet Industrial
Video



GET TO KNOW PANDUIT

https://pages.panduit.com/catalogo_entrenamientos_2020.html

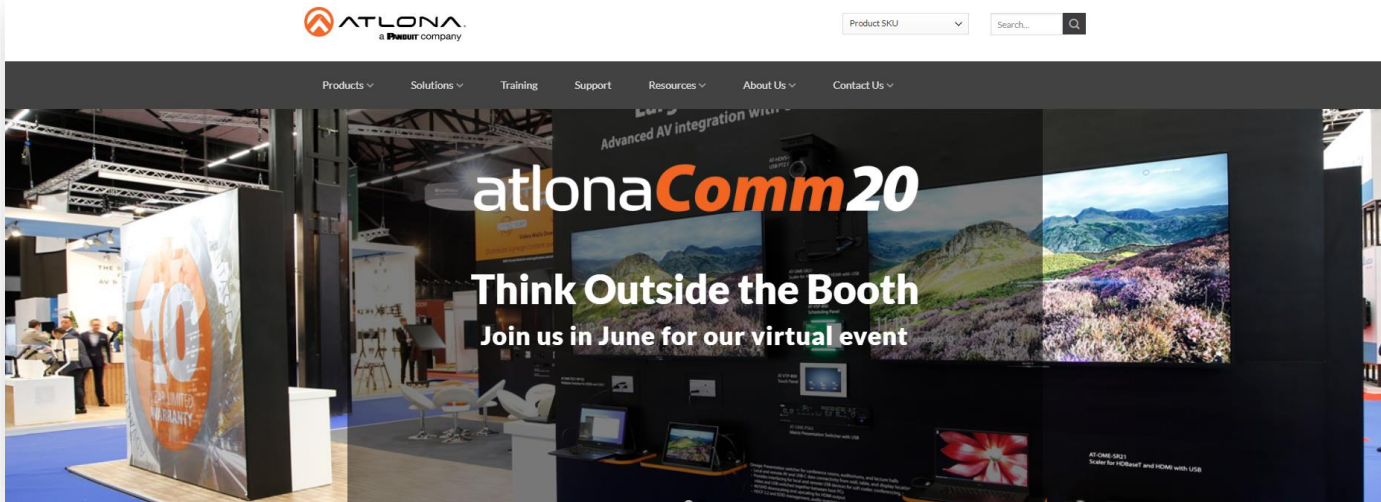

AtlonaComm20 representa una respuesta proactiva de parte de Atlona a la interrupción de eventos relacionados con el COVID-19. Se trata de pensar fuera del booth y de encontrar los carriles alternativos para impulsar un compromiso significativo con todos nuestros clientes y Socios de Negocios.

El exclusivo evento en línea ofrecerá un calendario completo de ofertas de productos, experiencias de formación y educación, y oportunidades de reunión personalizadas con los visitantes. [#atlona](#) [#gettoknowatlona](#)

Inscribirte: <https://lnkd.in/gWPDPzR>



Próximo webinar – **Martes 9 de junio a las 10hrs (GMT-5)**



PANDUIT

**Sesión 13:
Soluciones de
Audio y Video
Digital con
Atlona**

Martes 9 de junio
MX - COL - ECU - PER - 10 hrs.
CL - BOL - 11 hrs.
ARG - BR - URY - 12 hrs.

**GET TO
KNOW
PANDUIT**

Conectando Empresas a un Mundo de Posibilidades

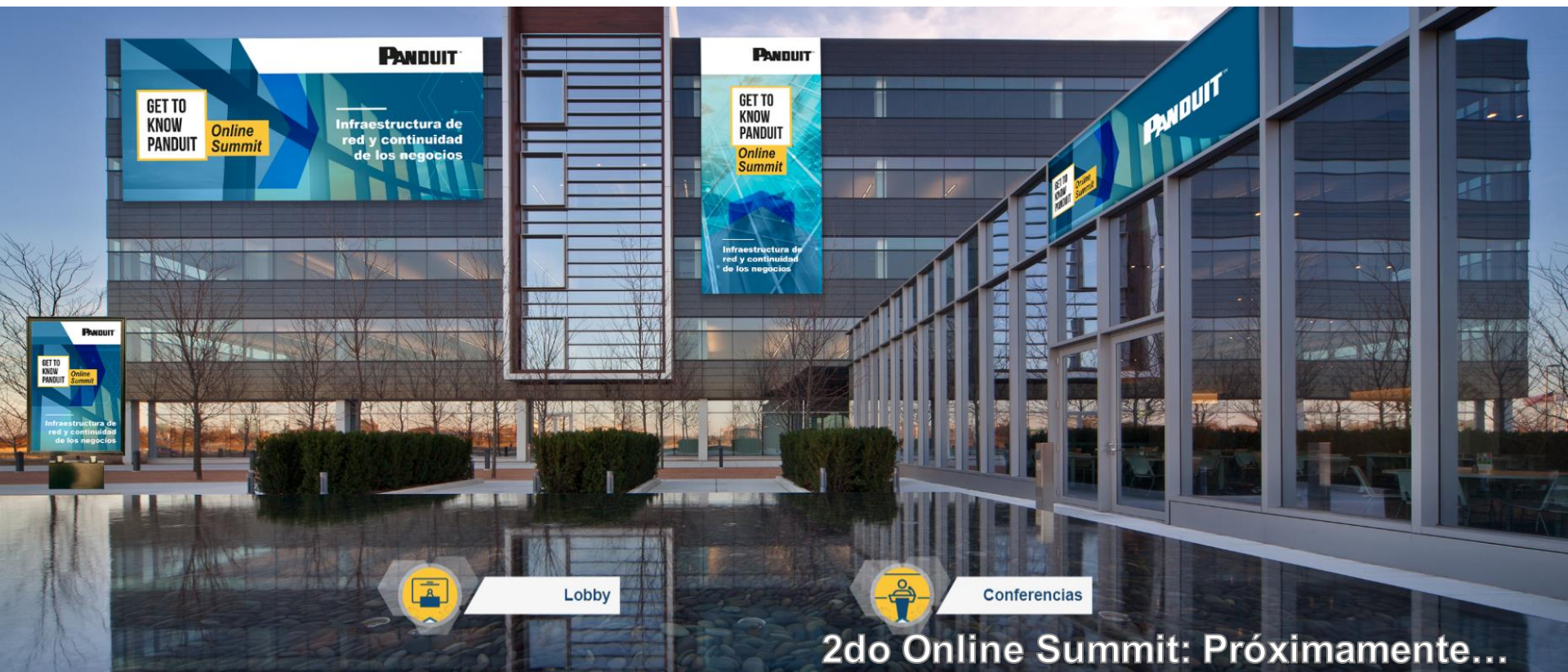

Lobby



Conferencias

2do Online Summit: Próximamente...

Infraestructura para un mundo conectado

PANDUIT™



Más de 60 años de innovación

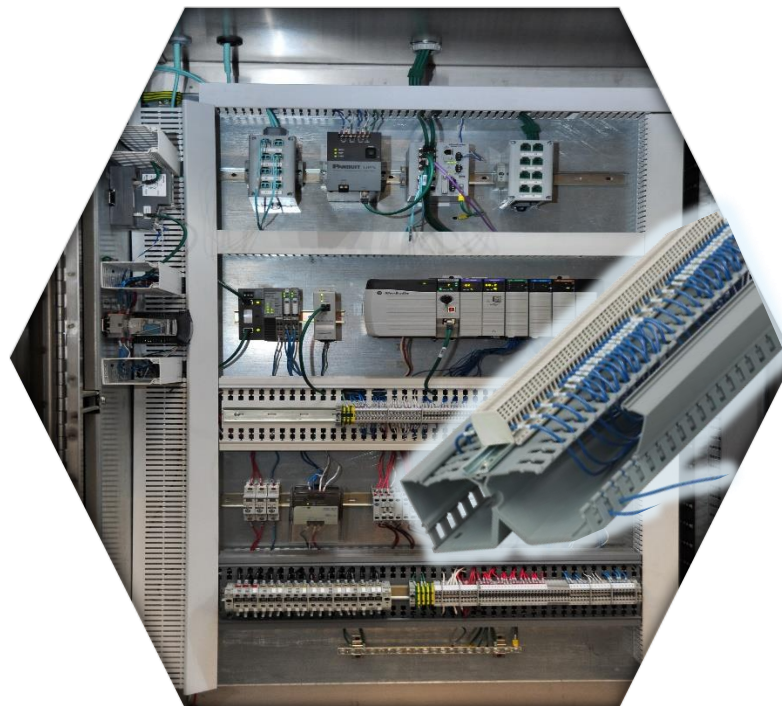
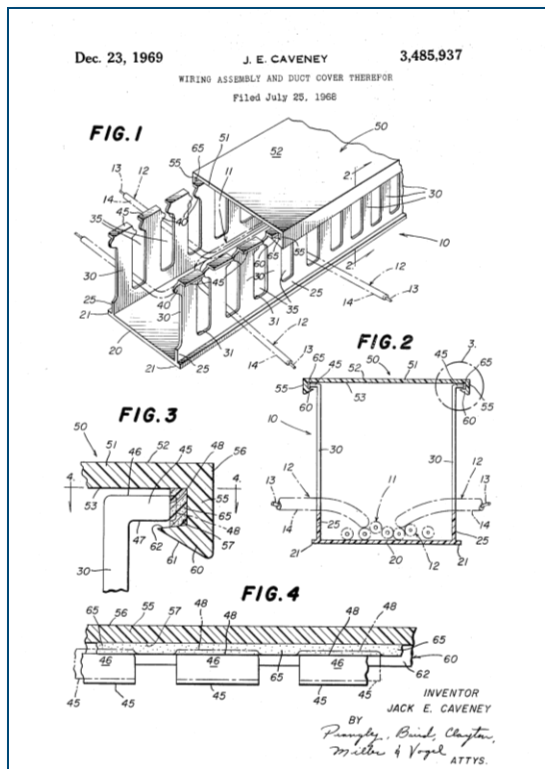

Habilitación de infraestructura estratégica para aplicaciones críticas

IC/MRO



OEM



Enterprise



Data Center



Industrial



La cartera más amplia de la industria, respaldada por un ecosistema global

Enterprise



**Copper and Fiber
Connectivity**



**Cabling and Cable
Management**



Fiber Termination



**Outlets & AV
Systems**



Data Center



**Fiber Connectivity
Solutions**



**Cabinets and
Pathways**



**Power
Distribution Units**



**Converged
Infrastructure Solutions**



Industrial Network



**Industrial Network
Zone System**



Micro Data Center



Connectivity



**Industrial
Distribution Frame**



Enterprise



Copper and Fiber Connectivity



Cabling and Cable Management



Fiber Termination



AV Systems & Outlets



Innovation and Technology



250,000 sq. ft.
Innovation Center



200
R&D Personnel



18
Laboratories



28% of sales
are from products
introduced in the
past 5 years



Influence
Standards
Bodies

PANDUIT INFRASTRUCTURE: Solutions for a Connected World

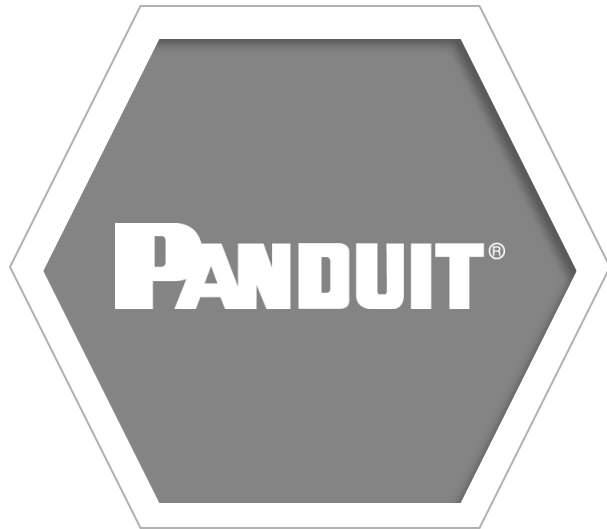

A 60-YEAR
LEGACY OF
TRUST

SUPERIOR
PRODUCTS
THAT SOLVE
PROBLEMS

BREAKTHROUGH
INNOVATION
THAT DRIVES
GROWTH

Agenda

Neyton Avila

- Tendencias Tecnológicas en Audio y Video
- Soluciones en Audio y Video: Empresarial, Industrial, Retail, Educación.

Erick Carmona

- ATLONA by Panduit
- Introducción al portafolio de soluciones y productos de Audio y Video ATLONA

Conclusiones



Tendencias Tecnológicas AV



GET TO
KNOW
PANDUIT

ENCUESTA DE IMPACTO AVIXA AV INDUSTRY COVID-19 PARA EL 1 DE MAYO DE 2020



Esta semana, el porcentaje de proveedores de AV y usuarios finales de AV que indica que la pandemia ha impactado negativamente en el negocio de su empresa disminuyó a 71% y 64%, respectivamente, frente al 79% y 67% de la semana pasada.

Significativamente, fue una semana relativamente tranquila para algunos proveedores de AV, con un 27% que no informó ningún impacto de la pandemia del virus, en comparación con solo el 19% que dijo lo mismo en la encuesta anterior.

Profundizando en las respuestas de los profesionales que dicen que han evitado los impactos negativos durante la semana, una proporción cada vez mayor puede discernir desarrollos positivos. Cuando se les preguntó por las buenas noticias, el 35% de los proveedores de AV que no habían visto un impacto negativo la semana pasada, incluido el 57% de dichos proveedores fuera de América del Norte, indicaron que vieron la reanudación de los proyectos. En ese sentido, el 30% de dichos proveedores de AV, incluido el 61% fuera de América del Norte, dijo que había visto un aumento en las consultas comerciales entrantes.

Lo mismo ocurre con los clientes finales. Hubo un número menor que indica que no hubo efectos negativos para la semana, pero entre ellos, el 28% dijo que habían visto reanudar los proyectos.

<https://www.avixa.org/insight/Articles/Details/avixa-av-industry-covid-19-impact-survey-for-may-1-2020/>

Modalidad de Trabajo



VideoConference

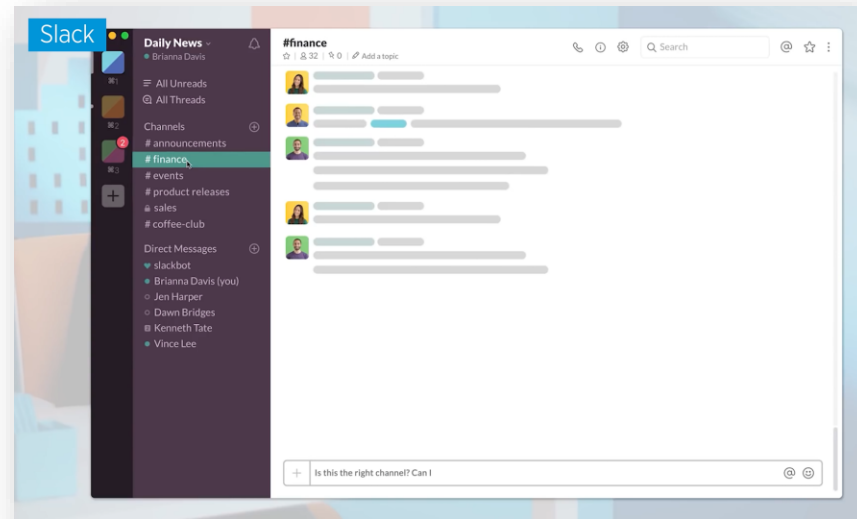

Communication

Actividades en Casa

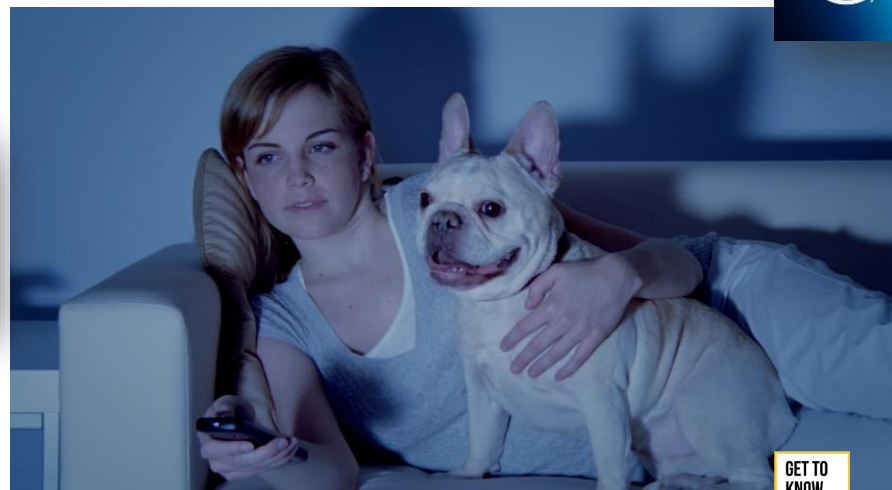
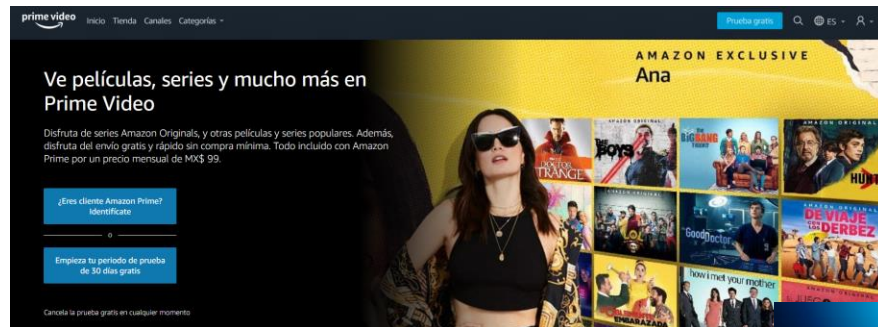
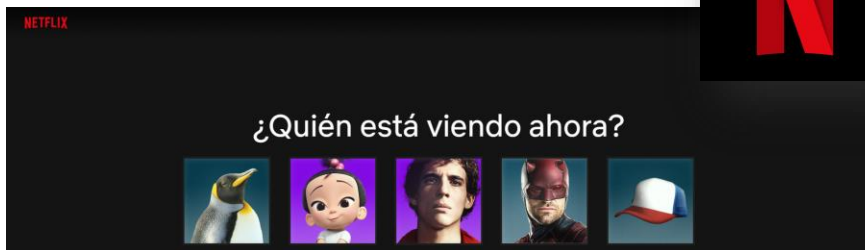

Cambios en los Modelos de Negocio

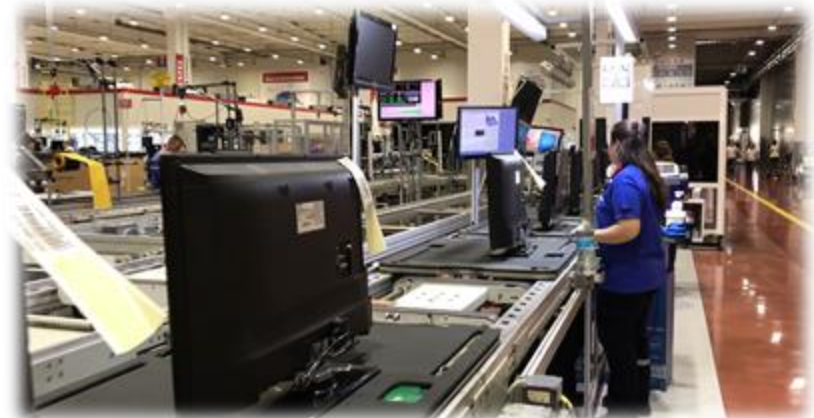

Factory 1



Factory 2

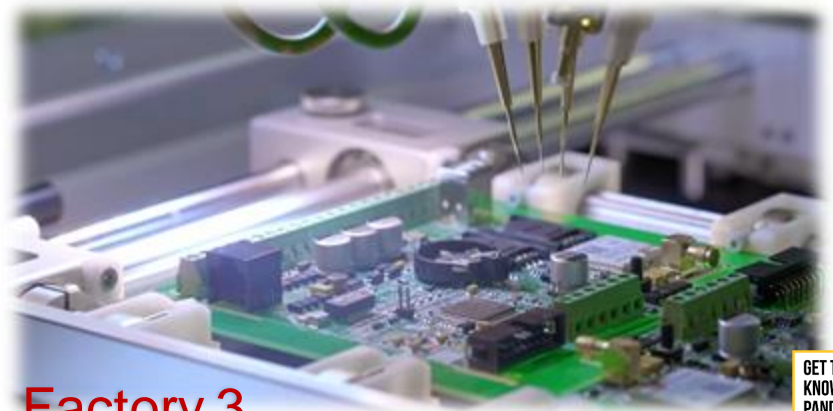

Factory 3

Tendencia # 1: La creación de video a escala se convierte en prioridad

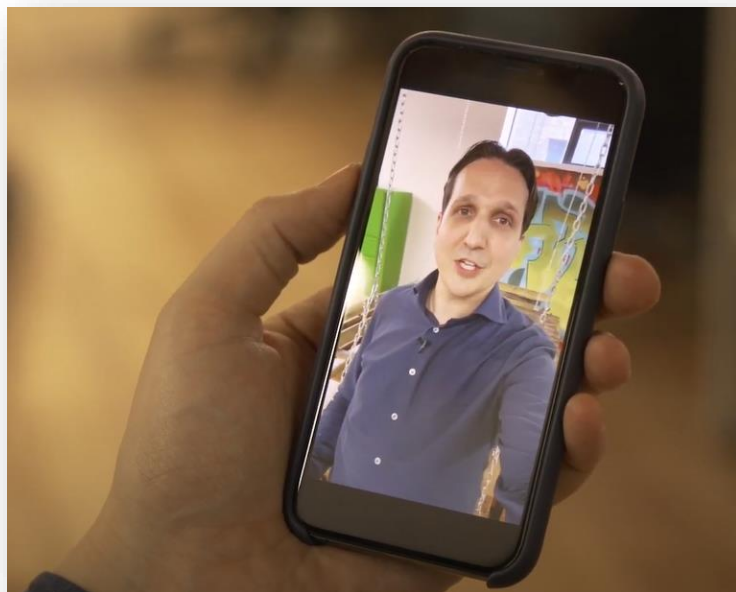

Uso de Videollamadas para asuntos
Personales y laborales



Contenido de Video en alta resolución (4K) será
uno de los habilitadores más importantes para la
Industria en temas de negocio

GET TO
KNOW
PANDUIT

Tendencia # 2: El video en el proceso de ventas ser convertirá de ser táctico a estratégico

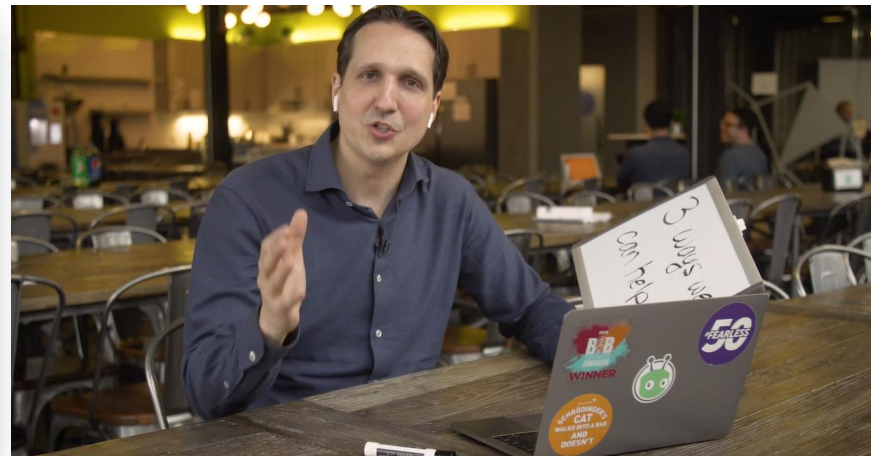
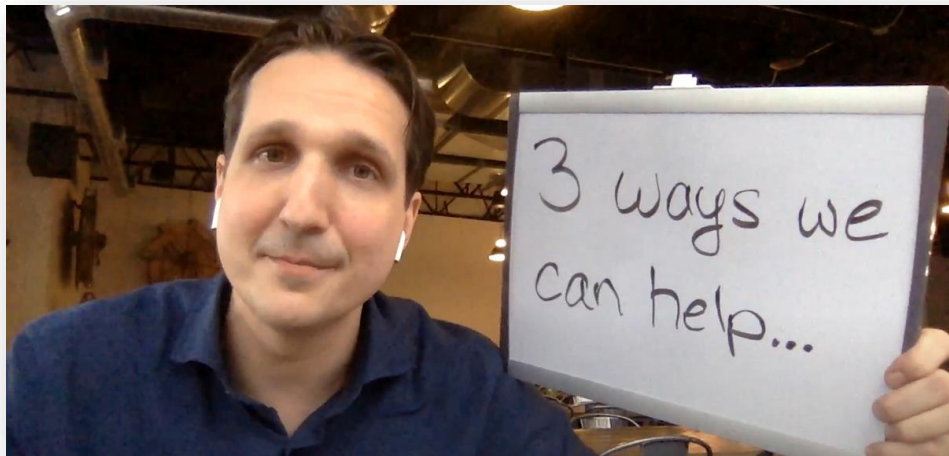

Los gerentes de cuenta recurrirán al video para devolver el toque humano a la gestión de las relaciones con los clientes

Tendencia # 3: Un nuevo rol para el video en las comunicaciones internas

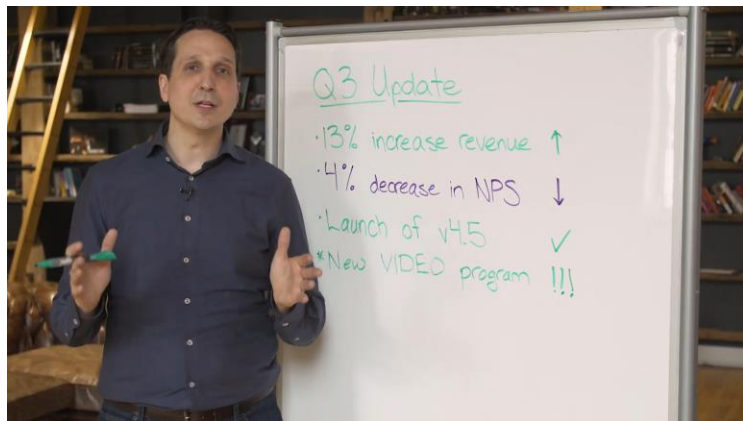

Cisco Webex Events



Improve reach, effectiveness, and results

Create highly engaging web events and reach more attendees, across the country and around the world. Communicate easily and affordably with internal and external audiences. Promote events more effectively and track results. Rely on highly secure and scalable online events from the global Cisco Webex platform.

[Read overview](#) [Compare products](#)

Collaboration Corner
Cisco Webex
Meetings

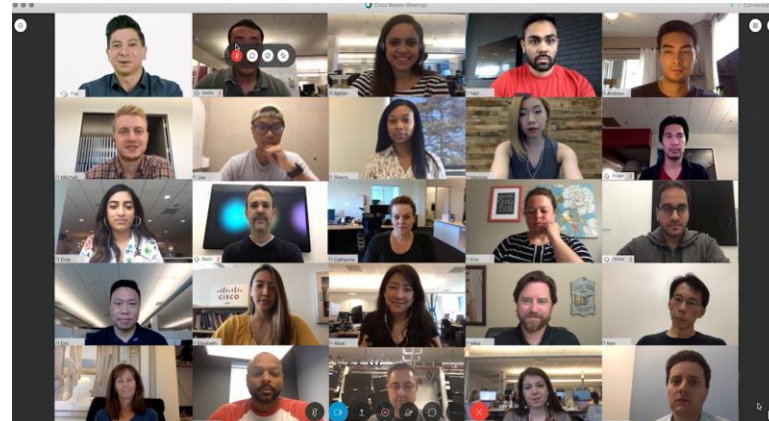

Adopción de nuevas plataformas virtuales para la habilitación de Video en los entrenamientos, reuniones y Comunicaciones internas.

Magic Quadrant for Meeting Solutions



GoToConnect

El sistema de telefonía para empresas. Jive y el software de reuniones GoToMeeting se han unificado en un solo producto.

GoToWebinar

Seminarios web pensados para facilitar la interacción con los participantes, estén donde estén y en cualquier momento.

GoToTraining

Amplie sus recursos de formación y mejore los resultados con herramientas de colaboración, sencillas soluciones para compartir pantalla, grabaciones y un sistema de configuración con un solo clic.

GoToMeeting

El software de reuniones online de cabecera que millones de usuarios utilizan para comunicarse y colaborar en cualquier dispositivo y cualquier lugar.

GoToRoom

Equipos prácticos y rápidos para salas de conferencias combinados con un intuitivo software de videoconferencias.

Grasshopper

La forma más profesional de responder a las llamadas locales o a líneas gratuitas. Todas las funciones de comunicación que necesita para el día a día de su empresa.

Una empresa, infinitas posibilidades.

Con una plataforma utilizada por decenas de millones de usuarios cada día y que está detrás de mil millones de interacciones con clientes y 20.000 millones de minutos de voz al año, LogMeIn tiene la confianza de empresas de todos los tamaños que quieren redoblar su apuesta por la comunicación.

- GoToConnect**: El sistema de telefonía Jive y el software de reuniones virtuales GoToMeeting se han unificado en un solo producto.
- Bold360**: Un chatbot conversacional y una solución virtual de asistencia que transforma la manera de interactuar con los clientes.
- LastPass**: Deje de perder el tiempo escribiendo contraseñas. Una contraseña maestra controla todas las demás y las mantiene bloqueadas en una bóveda segura.
- GoToMeeting**: El software de reuniones de cabecera que millones de usuarios utilizan para comunicarse y colaborar en cualquier dispositivo y cualquier lugar.

Ver todos los productos

Critical Capabilities for Meeting Solutions (Gartner)

Critical Capabilities Use-Case Graphics

Figure 1. Vendors' Product Scores for Internal Collaboration Use Case

Product or Service Scores for Internal Collaboration

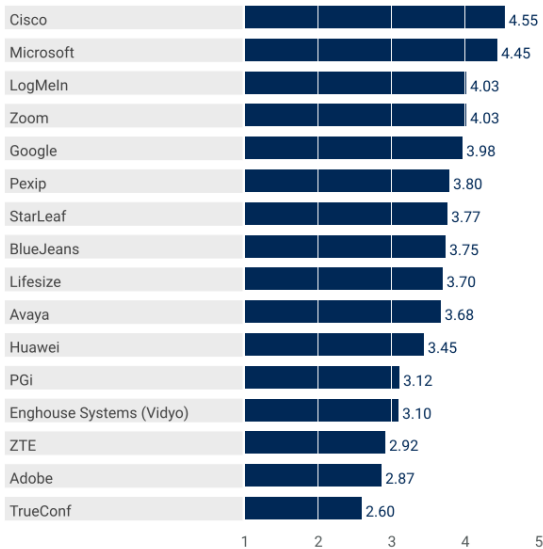

As of 30 September 2019

© Gartner, Inc

Source: Gartner (October 2019)

Figure 2. Vendors' Product Scores for Learning and Training Use Case

Product or Service Scores for Learning and Training

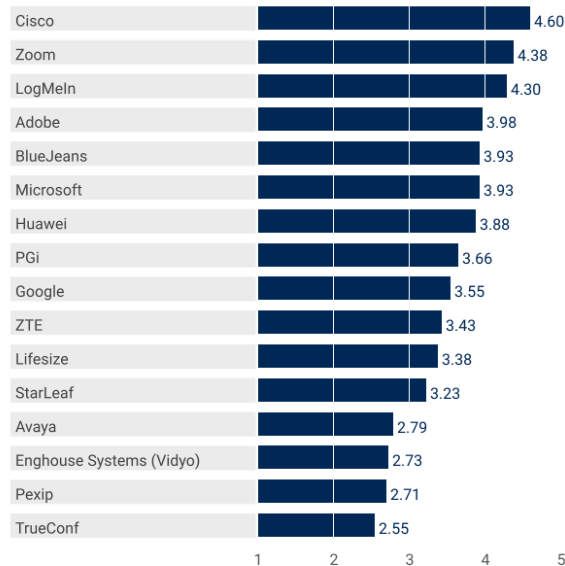

As of 30 September 2019

© Gartner, Inc

Source: Gartner (October 2019)

Continuación...

Figure 3. Vendors' Product Scores for External Presentation Use Case

Product or Service Scores for External Presentation

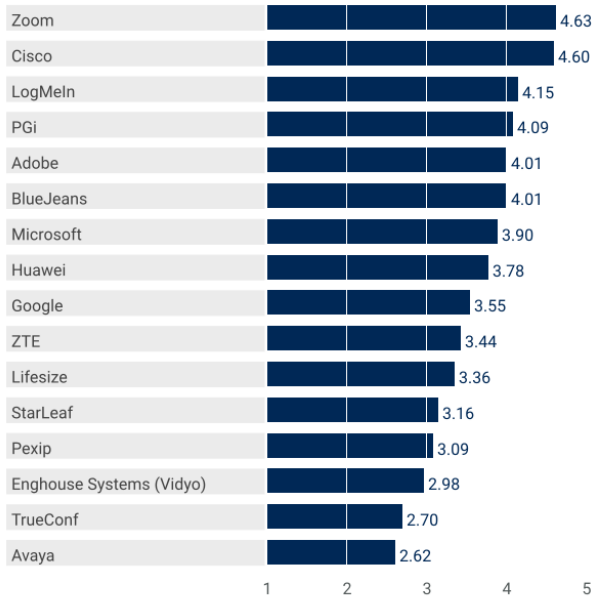

As of 30 September 2019

© Gartner, Inc

Source: Gartner (October 2019)

Figure 4. Vendors' Product Scores for Webinars Use Case

Product or Service Scores for Webinars

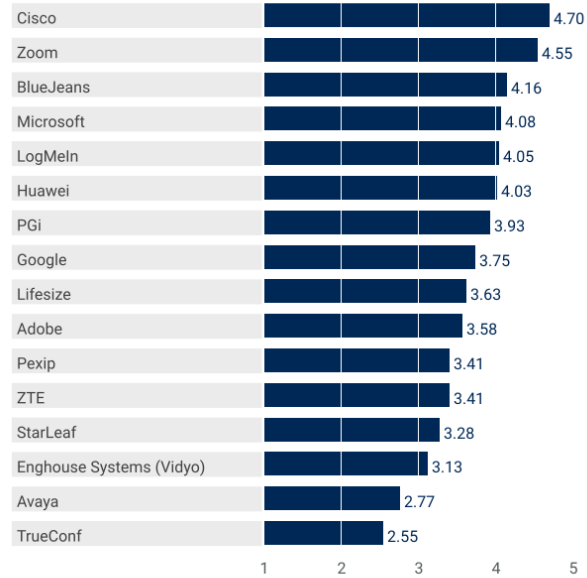

As of 30 September 2019

© Gartner, Inc

Source: Gartner (October 2019)

Cisco Webex: A Leader in Meeting Solutions

Magic Quadrant for Meeting Solutions

Cisco Webex meeting solutions #1 for ability to execute and completeness of vision

Critical Capabilities for Meeting Solutions

Cisco Webex Meetings received the highest leading scores of any vendor across all four use cases...

- 1) Teamwork
- 2) Presentations
- 3) Training
- 4) Webinars

Enterprise Videoconferencing Assessment

Cisco ranked as the overall leader and our solution placed highest for both capabilities and strategies

Gartner



Gartner

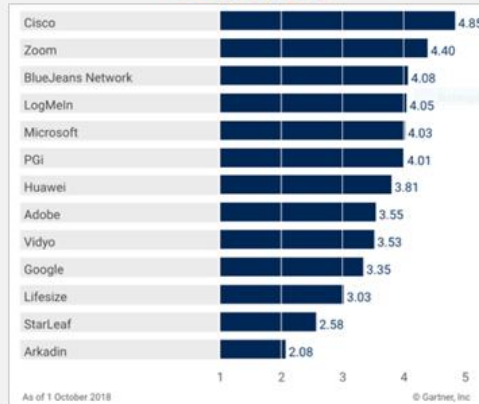

IDC

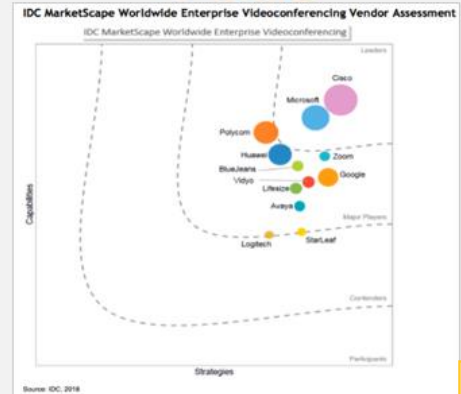

GET TO KNOW PANDUIT

Power of Cisco Webex: Infrastructure



**GET TO
KNOW
PANDUIT**

Cisco Brings the Power of Collaboration to Individual Productivity Tools

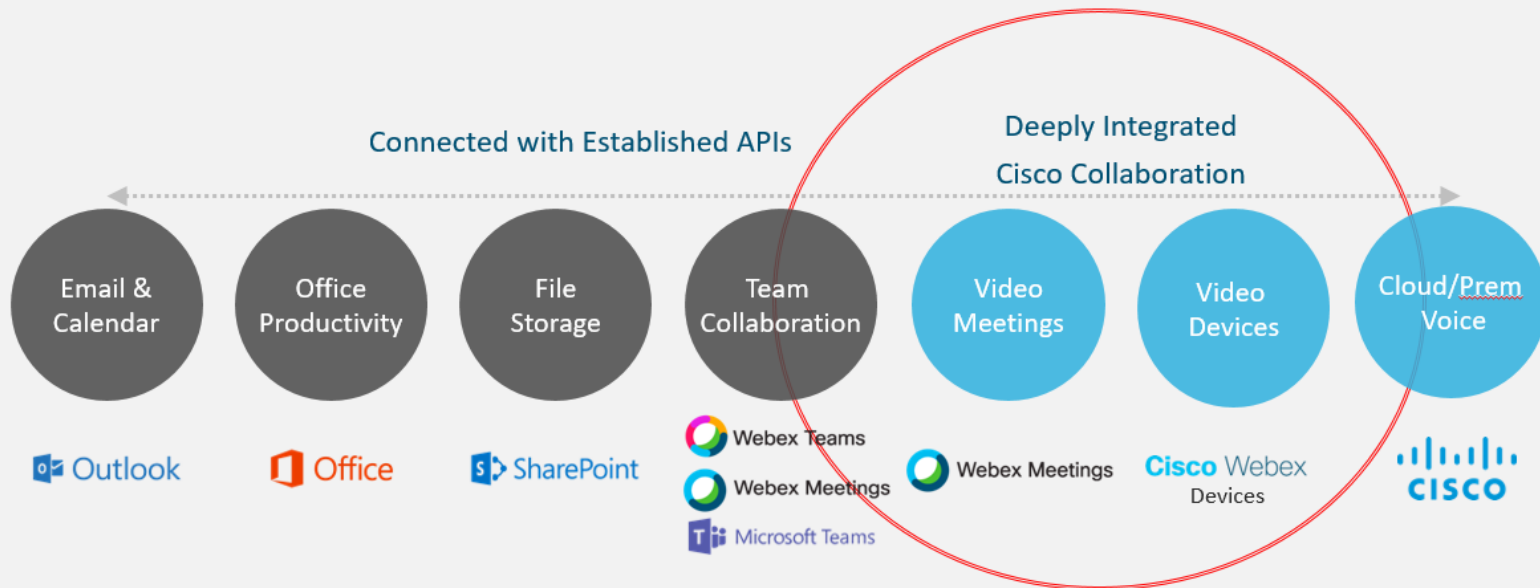

Seamlessly Meet, Communicate, Create, Share and Get Work Done with Your Team

¿Cuál es tu herramienta virtual de colaboración preferida?



GoToConnect

El sistema de telefonía para empresas Jive y el software de reuniones GoToMeeting se han unificado en un solo producto.

GoToWebinar

Seminarios web pensados para facilitar la interacción con los participantes, estén donde estén y en cualquier momento.

GoToTraining

Amplie sus recursos de formación y mejore los resultados con herramientas de colaboración, sencillas soluciones para compartir pantalla, grabaciones y un sistema de configuración con un solo clic.

GoToMeeting

El software de reuniones online de cabecera que millones de usuarios utilizan para comunicarse y colaborar en cualquier dispositivo y cualquier lugar.

GoToRoom

Equipos prácticos y rápidos para salas de conferencias combinados con un intuitivo software de videoconferencias.

Grasshopper

La forma más profesional de responder a las llamadas locales o a líneas gratuitas. Todas las funciones de comunicación que necesita para el día a día de su empresa.



Agenda

Neyton Avila

- Tendencias Tecnológicas en Audio y Video
- [Soluciones en Audio y Video: Empresarial, Industrial, Retail, Educación.](#)

Erick Carmona

- ATLONA by Panduit
- Introducción al portafolio de soluciones y productos de Audio y Video ATLONA

Conclusiones



Introducción

- AV ha pasado de análogo a digital y digital IP
- Convergencia de baja tensión e integración AV
- Habilitación del Departamento TI para el control de AV



Technology Trend: HDBaseT 2.0

Audio Video

- Ultra HD/4K uncompressed video
- CEC, EDID, HDCP included

USB

- 2.0 compliant
- Works for touch screens, USB extension, smartboards

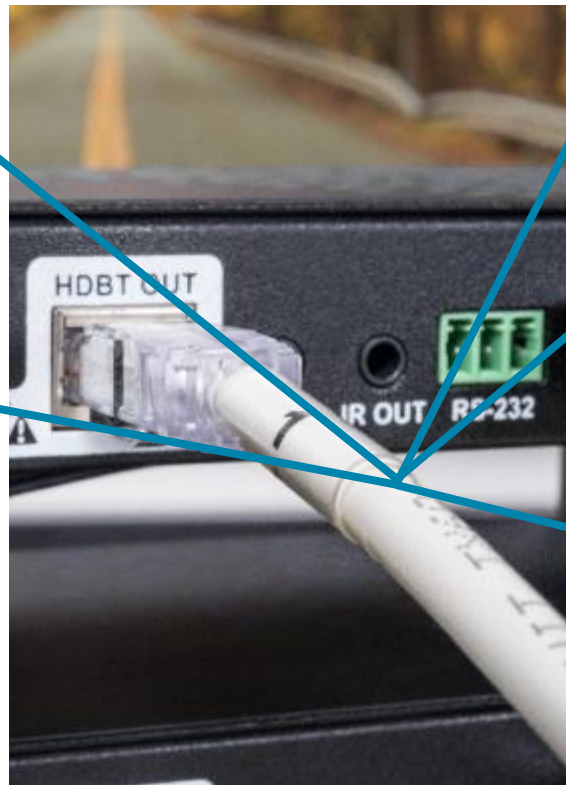

Ethernet

- 100BaseT Ethernet Supported

Control

- Control channels
- RS-232 and IR Supported

Power

- Transmits up to 100W of DC power

Revision general HDBaseT

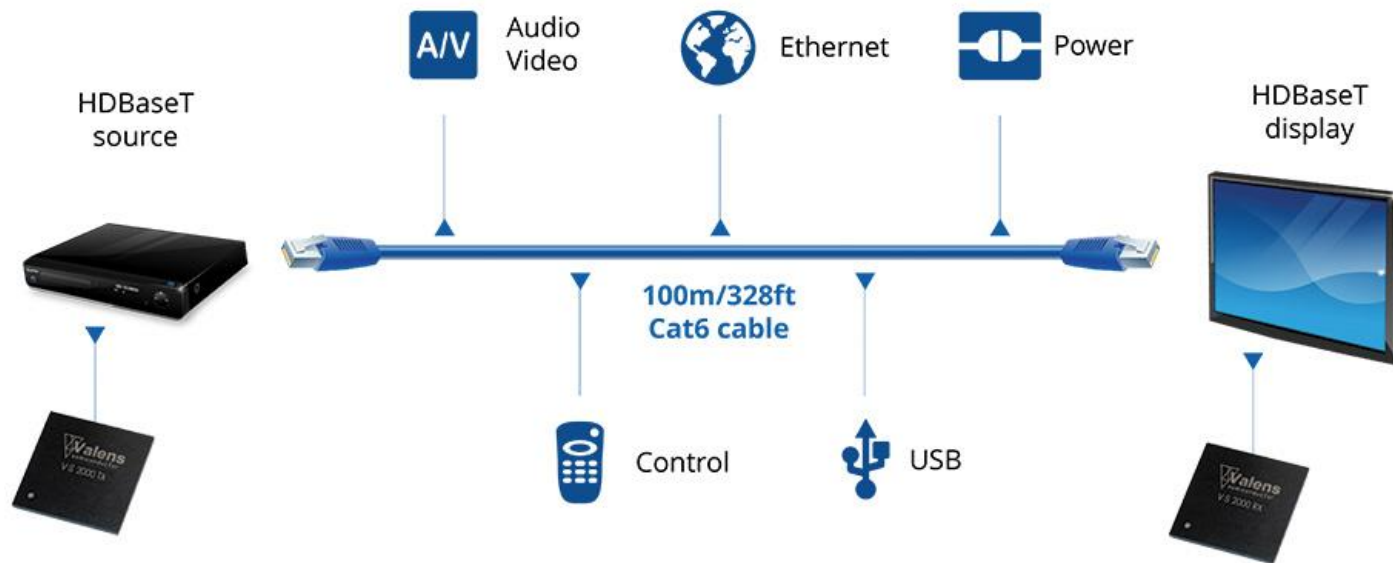

Number of Network Links/Nodes are Growing

- Distributed Building connections increase
 - **3.5M** in 2016 - **9M** in 2021
 - 20%-25% per year from 2018 - 2021
 - Growth from a low base
- Physical security most installed products
- PoE LED lighting explosive growth
- PoE grows with number of devices

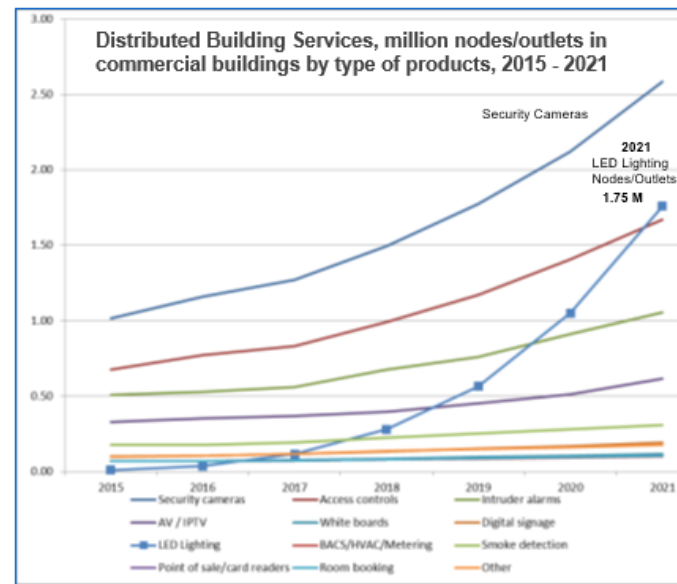

Business Demand More From Their Workplace



- Attract and retain best talent
- Improve employee productivity
 - Adaptive
 - Personalized
- Optimize real-estate
 - Efficient use of space
 - More flexible work spaces
- Energy savings

Entendiendo el ancho de banda en AV



HDMI 1.4
HDBaseT

HDMI 1.4 / HDBaseT = 10.2 Gbps
4K/UHD, 60Hz, 4:2:0



4K
ULTRA HD TV
HDR

HDR Video > 11 Gbps



HDMI
2.0

HDMI 2.0 = 18 Gbps

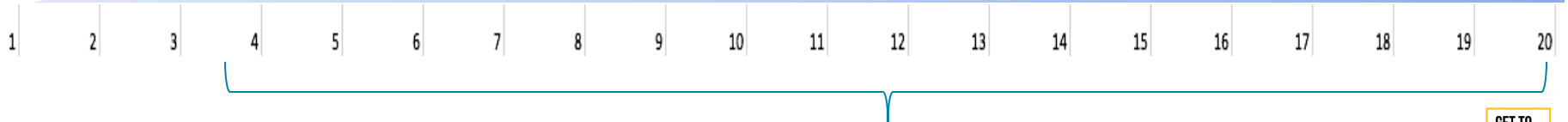

4K/UHD Bitrate = 3.5-18 Gbps



Bases del protocolo HDBaseT



Network Terminology

- 10BaseT = 10 Megabits (Standard Ethernet)
- 100BaseT = 100 Megabits (Fast Ethernet)
- 1000BaseT = 1Gigabit (Gigabit Ethernet)
 - **HDBaseT se mide en Gbs**
 - 10.2 Gbs = 10,200 Mbs
- HDBaseT
 - HD = Gigabit
 - Base = Baseband (one signal)
 - T = Cable Type (Twisted-Pair)

Que cable
debo usar?
CAT-5/6/7

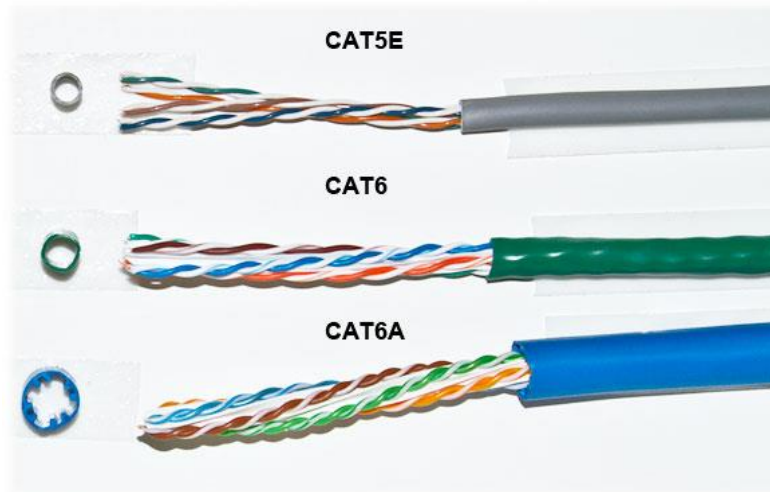

Cable Recomendado:
CAT6a Shielded

BEST SELLER

PUR6AV04BU-G [Share](#)

Copper Cable

Copper Cable, Cat 6A, Vari-MaTriX, 4-Pair, 23 AWG, UTP,

[Find A Distributor](#)

Qty

GET TO
KNOW
PANDUIT

Distancia de cable en HDBaseT

Selección de cable

- *El tipo de cable y la resolución determinaran el desempeño HDBaseT*

Valens VS100 Chipset Class A

Nominal 100m HDBaseT ≤1080p

- CAT5e /6 - 100 m (328')
- CAT6a / 7 - 100 m (328't)
- 1080p 3D hasta 4K
- CAT5e/6 - 70 m (230')
- CAT6a/7 - 100 m (328')

Valens VS010 Chipset Class B

Nominal 70m HDBaseT ≤1080p

- CAT5e/6 - 60 m (197')
- CAT6a/7 - 70 m (230')
- 1080p 3D hasta 4K
- CAT5e/6 - 35 m (115')
- CAT6a/7 - 40 m (130')

Start With The Digital Ceiling

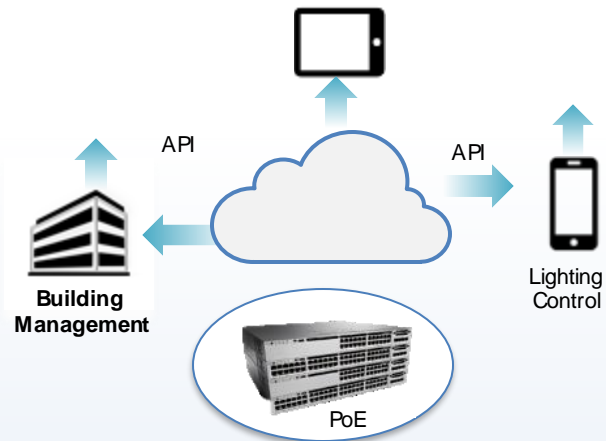

Start Here

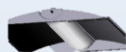

PoE LED Lighting



Sensors



Building Automation



HVAC



IP Video Surveillance Camera



Wi-Fi Access Point



GET TO KNOW PANDUIT

Where Does Panduit Fit In?



- Patch Panels
- Structured Cabling
- Connectors
- Plugs
- Field Terminable Plugs
- J-Hooks
- Cable Trays
- Enclosures
- Racks

The infrastructure that ties it all together!

Salas de conferencia ejecutiva



Salas de juntas



Video conferencia por Software



Integracion de audio



Sala de entrenamiento corporativo



Sala Divisible



Distribucion AV empresarial



Espacios de entretenimiento

Universidades



Distribucion AV en toda la casa



Distribucion AV en el campus



Salon de conferencias



Salon de conferencias



Salon de reuniones
Huddle Room



Salas de estudio



Sports Bar

Soluciones de Audio y Video para espacios de Colaboración

PANDUIT®

 **ATLONA**
a **PANDUIT** company



Agenda

Neyton Avila

- Tendencias Tecnológicas en Audio y Video
- Soluciones en Audio y Video: Empresarial, Industrial, Retail, Educación.

Erick Carmona

- [ATLONA by Panduit](#)
- Introducción al portafolio de soluciones y productos de Audio y Video ATLONA

Conclusiones



Panduit + Atlona: The New Leader in AV Solutions

Now, you can trust one company to provide an end-to-end AV solution for your conference rooms, training rooms, boardrooms, classrooms, and digital signage.

PANDUIT®



 **ATLONA**
a **PANDUIT** company

 **ATLONA.**

GET TO
KNOW
PANDUIT



Mission and Vision

Nos apasiona proveer a nuestros clientes con **innovación** que les permita **conectarse y colaborar con simplicidad**. Servimos a nuestros clientes proveyéndoles de **soporte de excelencia, presencia global y agilidad**.

Queremos ser el **proveedor de confianza de soluciones en conectividad audiovisual** necesarias en la industria, educación superior, corporativo y espacios residenciales mediante soluciones tecnológicas innovadoras.

Timeline of Innovation

Milestones



2003

2003 Founded in the heart of Silicon Valley with a focus around digital signal distribution

2007 Transitioned to R&D-based company

2010 Launched professional grade HDMI switcher

2007

2010

2011

2011 Joined HDBT alliance; Introduction of brand new residential product portfolio; First CEDIA® show

2013 HDVS AV Switcher Series introduces the “Zero UI Meeting Room” concept

2013

Timeline of Innovation

Milestones

20
15

2015 PRO3 Series – Leadership in 4K HDCP 2.2 AV matrix solutions

2016 HDVS-300 – Innovative solutions for hardware-based and software-based conferencing codecs

2017 OmniStream™ Pro – Pioneering company in network-based control;

2016

2017

2017, cont. SW-510W – Wireless BYOD made simple

2018 Introduces CrystalScale™ technology to scaler and switcher line up and launches USB over IP solutions

2019 Atlona becomes a Panduit company: The New Leader in AV Solutions

2018

2019

Fuerte presencia Global



Oficinas centrales



Oficinas de venta local



de empleados regionales

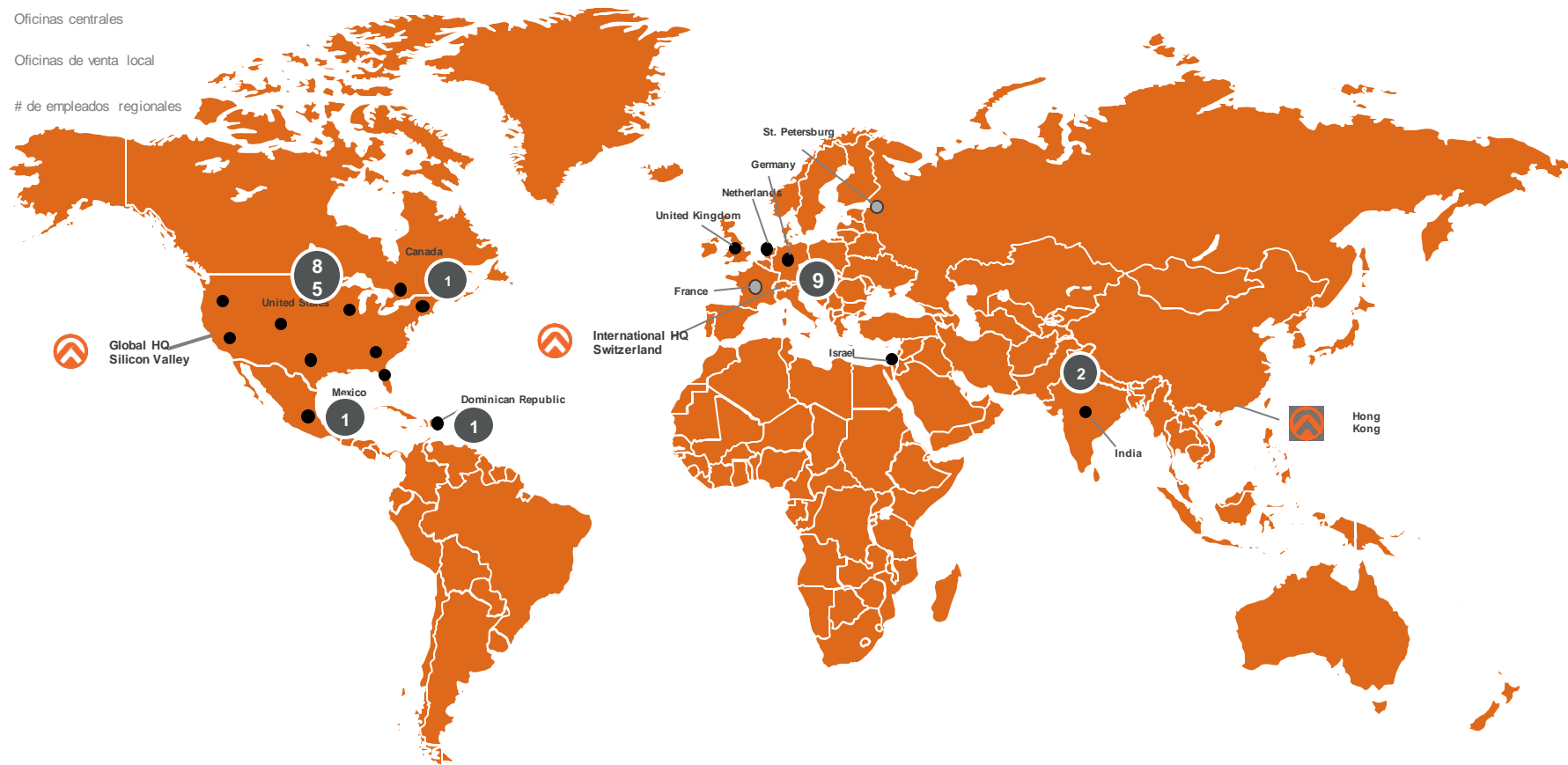

Solución Atlona + Panduit de principio a fin.

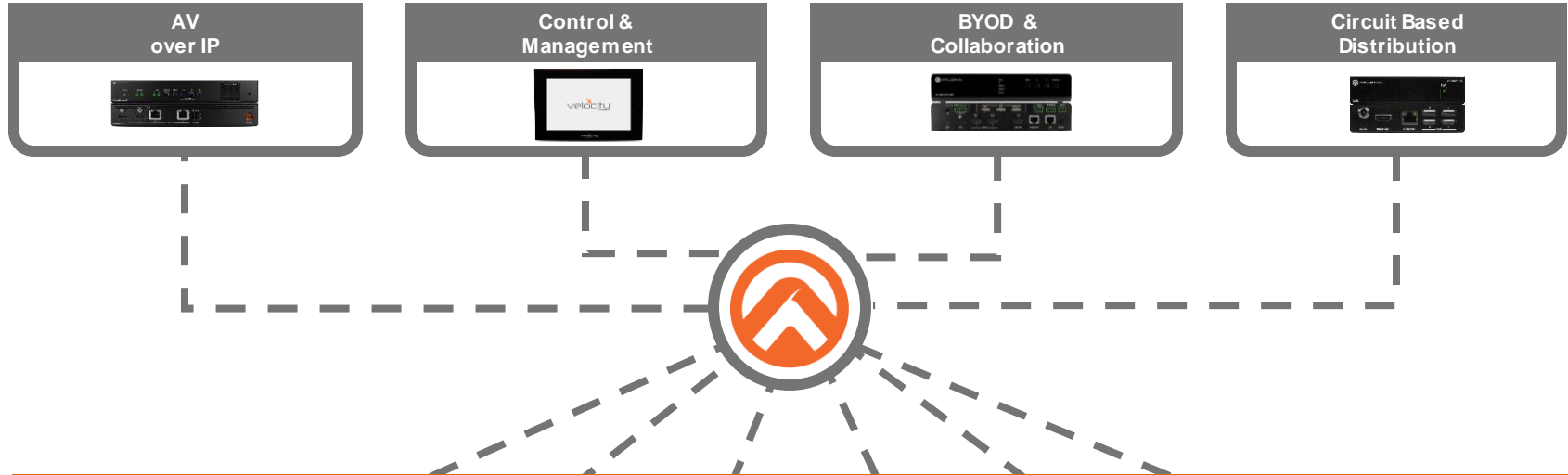

Enfocado a diversos segmentos de usuario final.



Negocios corporativos



Educación



Gobierno



Hospitalidad



Residencial



Entretenimiento

10 AÑOS DE GARANTÍA



Atlona Advantage



Por que Atlona



- Innovación
- Confiabilidad
- Credibilidad
- Portafolio complete de soluciones AV
- Entrenamiento y programa educativo galardonados
- Presencia Global



Solución Atlona + Panduit de principio a fin.

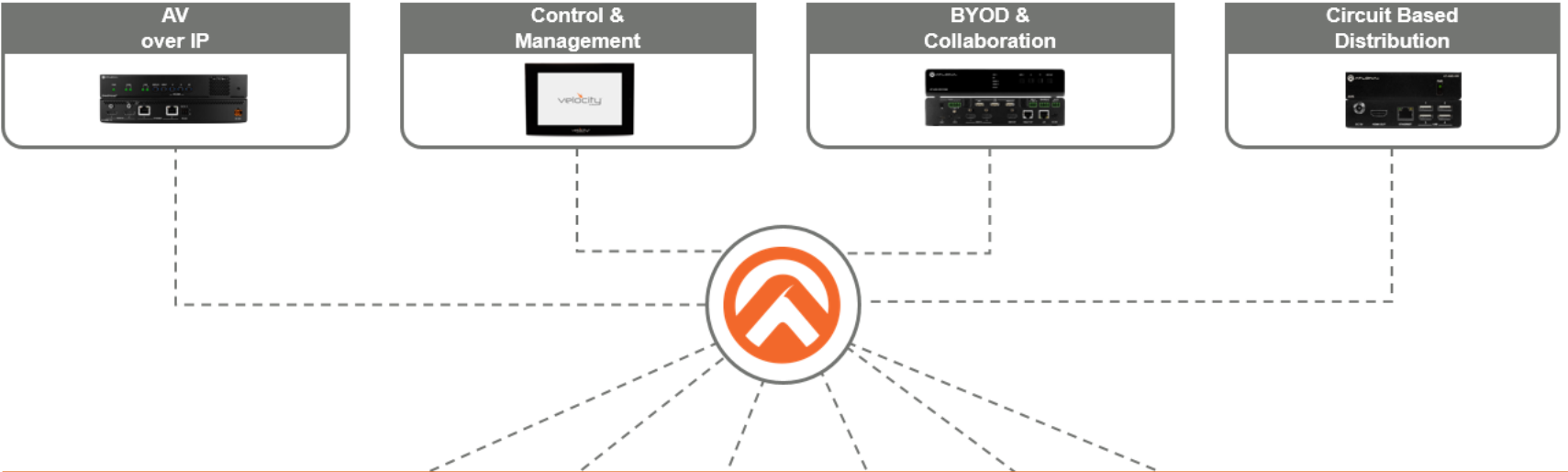

Enfocado a diversos segmentos de usuario final.

- 
Negocios corporativos
- 
Educación
- 
Gobierno
- 
Hospitalidad
- 
Residencial
- 
Entretenimiento



Ofrecer componentes para una solución



Ofrecer la solución!

Agenda

Neyton Avila

- Tendencias Tecnológicas en Audio y Video
- Soluciones en Audio y Video: Empresarial, Industrial, Retail, Educación.

Erick Carmona

- ATLONA by Panduit
- [Introducción al portafolio de soluciones y productos de Audio y Video ATLONA](#)

Conclusiones



El ecosistema Atlona

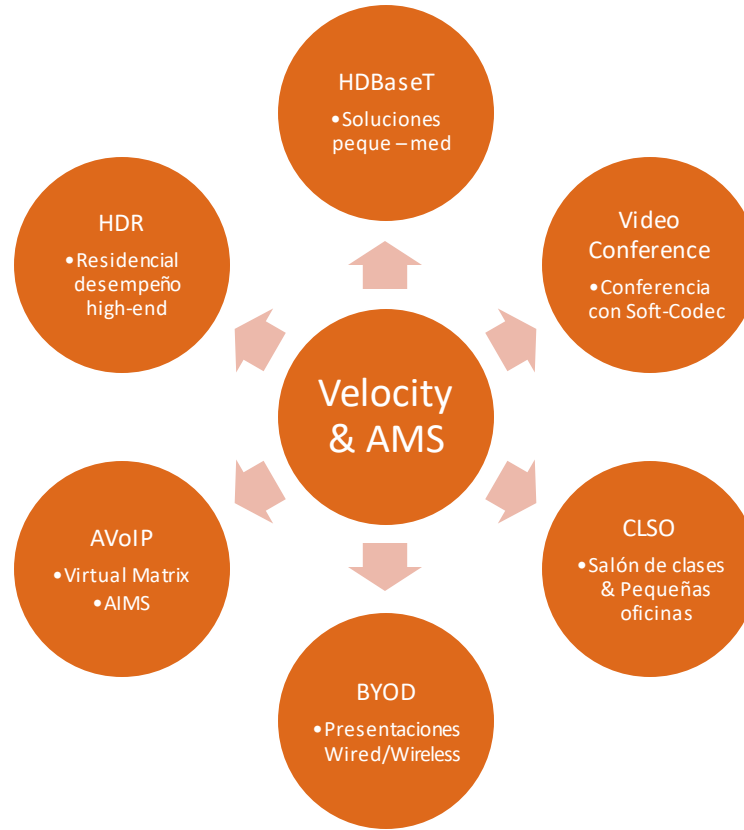

Solucion pequena: Gran valor!

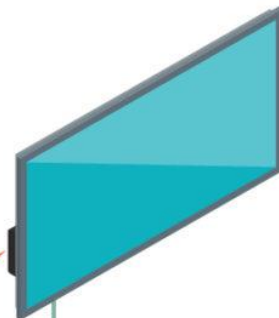
HDVS-150-RX**HDBaseT****HDVS-150-TX**

AT-HDVS-200-Series

El AT-HDVS-200-TX de Atlona es un switch 3x1 con control de pantalla para transmisiones HDMI y VGA por cable Ethernet para HDBaseT™.

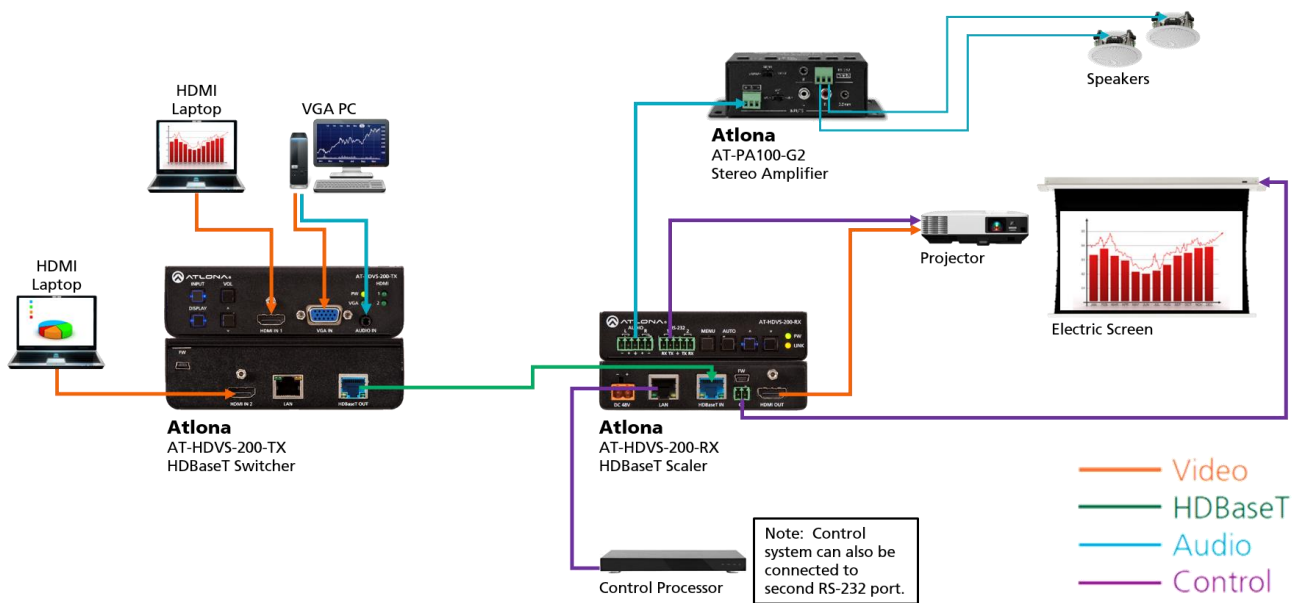

GET TO KNOW PANDUIT

Sala de reuniones ejecutivas



GET TO
KNOW
PANDUIT

Espacios de colaboracion. Huddle



Solucion para salas de junta pequenas HDVS-200

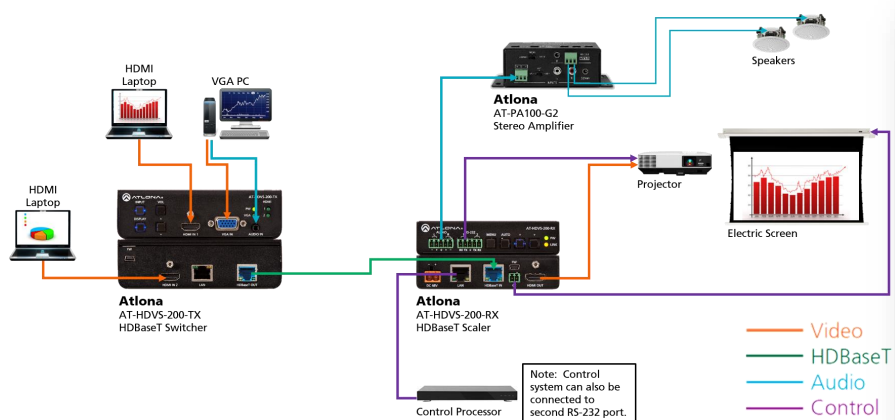

**GET TO
KNOW
PANDUIT**

Familia de productos HDVS-200

Transmisores HDVS-200-TX

- Switcher 3x1 HDBaseT™
- Extension HDBaseT, Ethernet habilitado
- Auto-switching
- Control TCP/IP y RS-232
- Selector de entradas en el Panel Frontal
- Auto displaycontrol
- Control de encendido de pantalla en el panel frontal
- Control de volumen en el Panel Frontal



Receptor HDVS-200-RX

- Escalador con salida HDMI y control de resolución de entrada
- Extension HDBaseT, Ethernet habilitado
- Control TCP/IP y RS-232
- Control de volumen
- Contactos secos para controlar pantallas motorizadas.
- Auto displaycontrol
- Facil, configuracion GUI usando el explorador de internet.
- PoE en el modelo AT-HDVS-200-TX

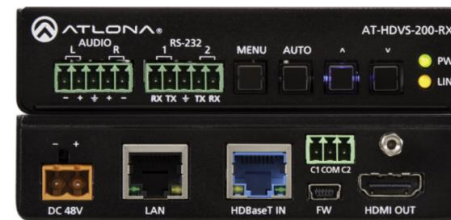

AT-HDVS-210U-TX-WP

- Empotrable en US1 gang TX
- 1x HDMI 2.0; 1x USB-C 1.3
- HDMI 2.0
- HDCP 2.2
- Puertos IR y RS Pass Through
- Transmision 100m / 330 feet
- Alimentacion via PoE del RX
- Compatibilidad inmediata con nuevas tecnologías de Laptops, tablets, y smartphones con Puerto USB-C upporting AV (**NOTA:** no soporta transferencia de datos ni carga USB)

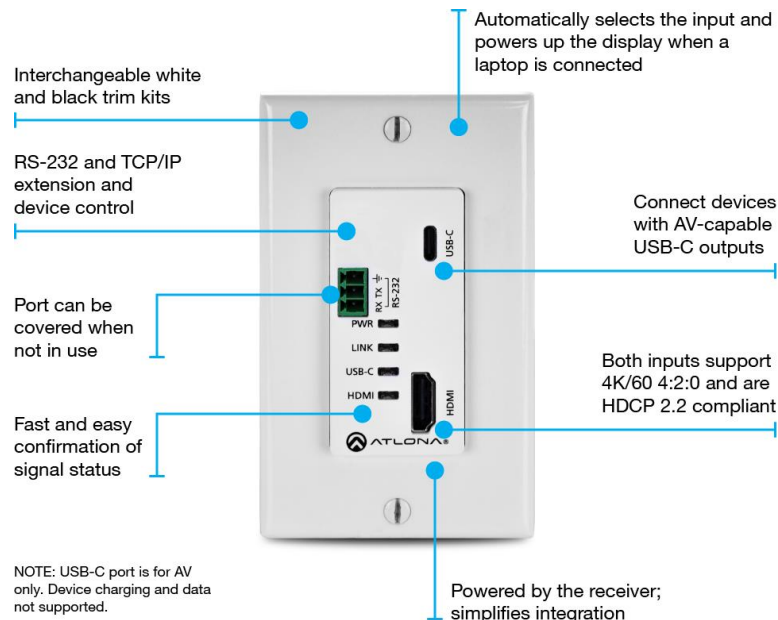

AT-HDVS-210H-TX-WP

- Chasis estilo Decora® de 1 gang (US) – Kits intercambiables Blanco y Negro
- Switch 2x1 HDBaseT™ con entradas HDMI®
- Ideal para usar con el escalador / receptor AT-HDVS-200-RX, el receptor AT-UHD-EX-100CE-RX-PSE, y otros Switches HDBaseT de Atlona
- El transmisor AV HDBaseT smitter for AV, funciona con hasta 100m de cableado
- Capacidad 4K/UHD @ 60 Hz con 4:2:0 de chroma subsampling (con el AT-UHD-EX-100CE-RX-PSE)
- Energizado remotamente via PoE
- Selecccion automatica de entradas y control automatic de pantalla.
- Control por TCP/IP y RS-232

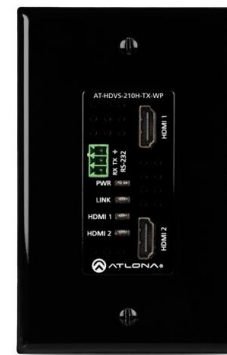
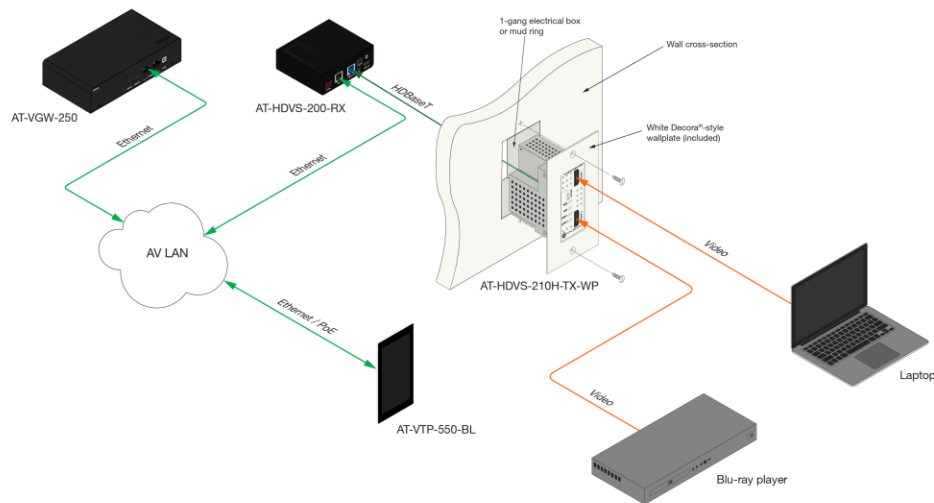

PKT-3H: Accesorio para cables en mesa: **Pocket**

- Ofrece acceso rapido
- El accesorio incluido sostiene 3 cables
- Diseño discreto de bajo perfil
- Se instala en superficies de hasta 50mm de ancho
- Incluye CableSleeve™ para asegurar los cables bajo la mesa



Pocket™
Architectural Cable Access
Enclosure for Three Cables

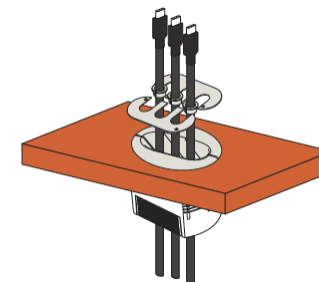
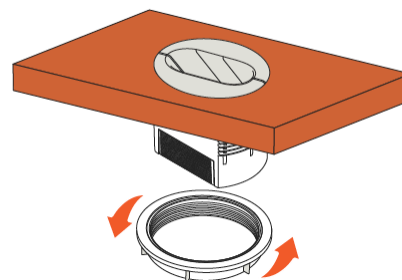

Solucion Huddle Space – SC-500

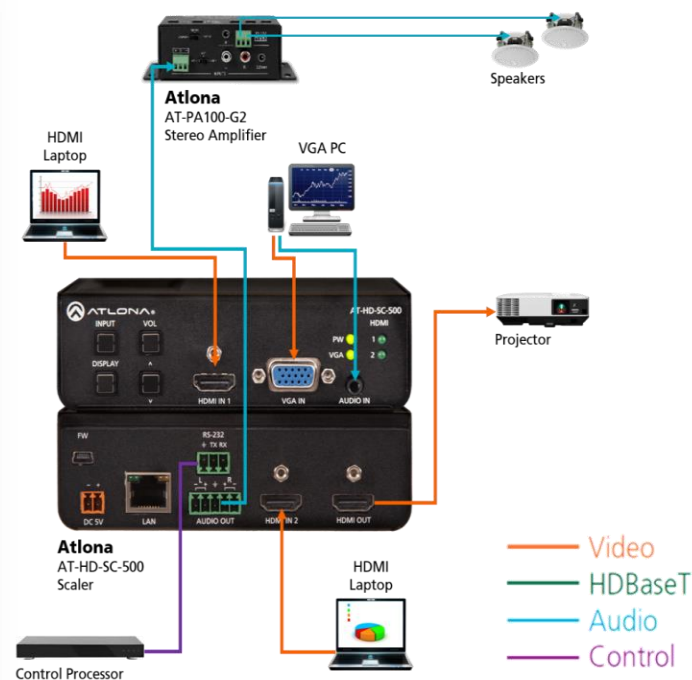

The image features a hand holding a smartphone in the foreground, displaying the Velocity 2.0 control interface. The interface includes a top status bar with icons for signal strength, Wi-Fi, and battery. Below that, there's a 'Sources' section with icons for 'Blu-Ray', 'Display', 'AirPlay', 'HDMI DVI', and 'Computer'. At the bottom, there's an 'Audio' section with a volume slider and the number '59'. In the background, a tablet is also displaying the same interface. The word 'velocity' is written in a large, white, lowercase sans-serif font, with '2.0' in a smaller font to its right. A trademark symbol (TM) is positioned above the 'y'. An orange arrow points downwards towards the 'y' in 'velocity'.

velocityTM 2.0

Simplified

AV Control, Room Scheduling, and Asset Management

Atlona **Velocity™**

IP-based AV control and management



Velocity – Pitch & Position

What is Velocity?

- A tool for controlling an AV application that allows an integrator to easily offer a complete end to end solution.

Why Velocity?

- Powerful control and customization for a fraction of the effort and cost of competing solutions.

What makes Velocity unique?

- Entirely cloud based solution with room scheduling, remote configuration and management.

What are key applications for Velocity?

- Corporate / Collaboration
- Education
- Government
- Hospitality



velocity
by Atlona

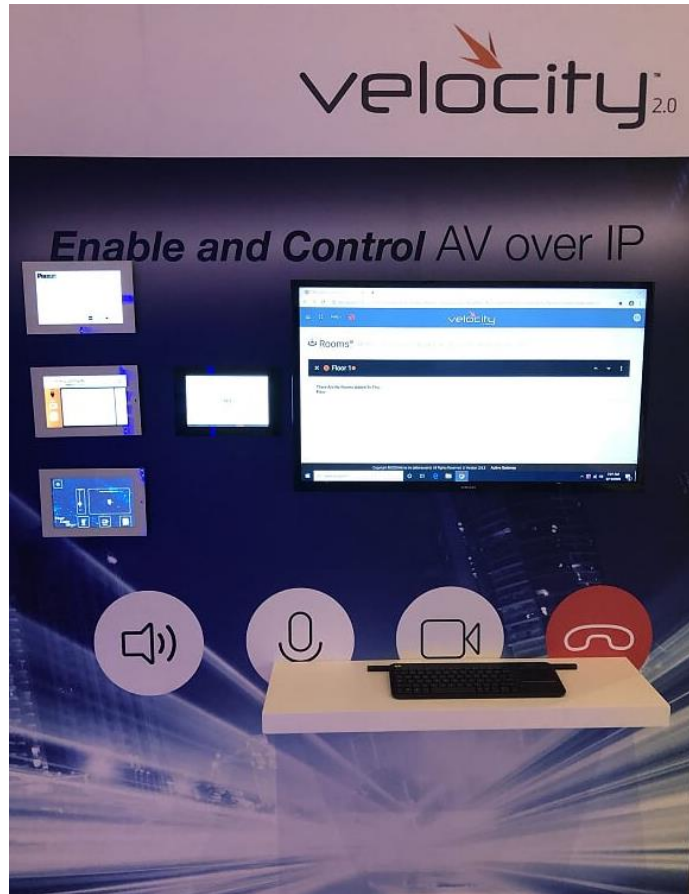
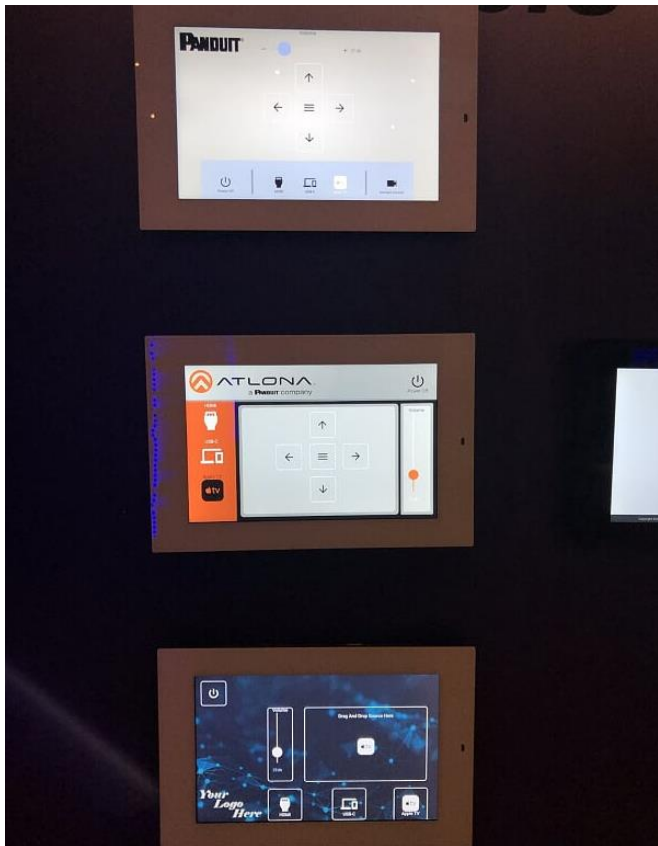

VELOCITY – Touch Pannels

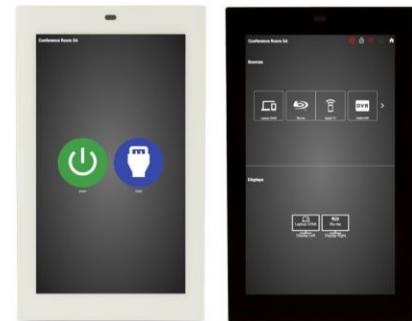

VTP-800



VTP-550

GSIC2020 – Evento Global de PANDUIT (Cancún 2020)



Video Wall
3X3



Video Wall
2X2



GET TO
KNOW
PANDUIT

GSIC2020 – Evento Global de PANDUIT (Cancún 2020)



GET TO
KNOW
PANDUIT

GSIC2020 – Evento Global de PANDUIT (Cancún 2020)



GET TO
KNOW
PANDUIT

Velocity – Room Scheduling

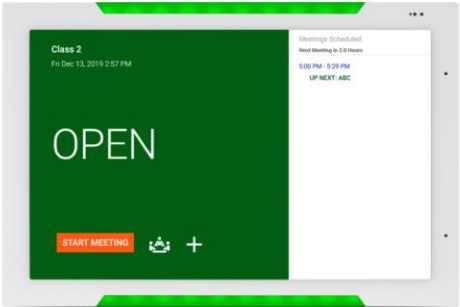
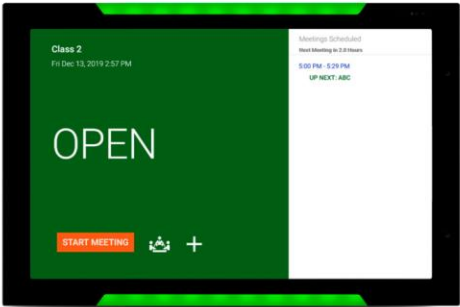
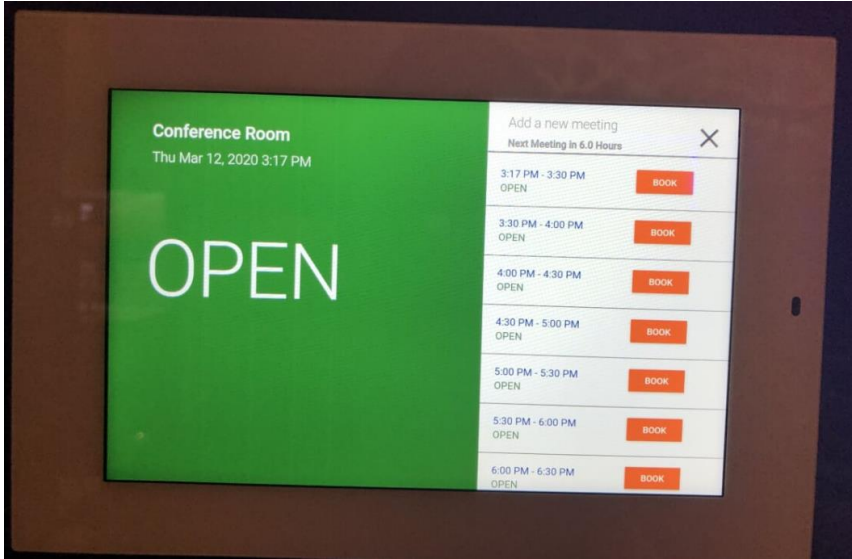
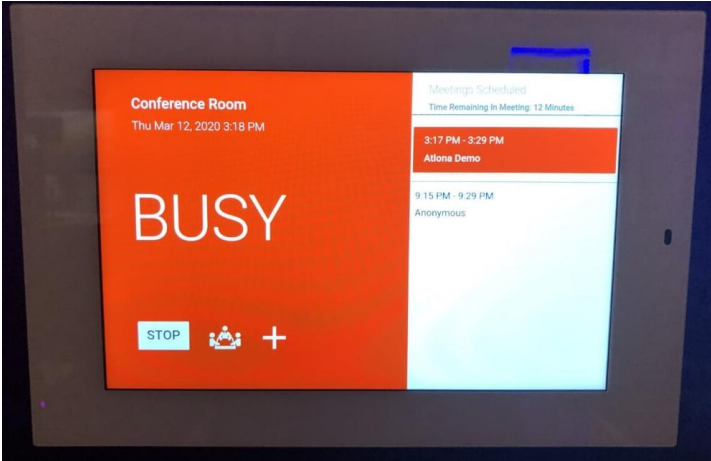

Velocity System 8" Scheduling Touch Panel

Velocity VSP-800 (Room Scheduling)

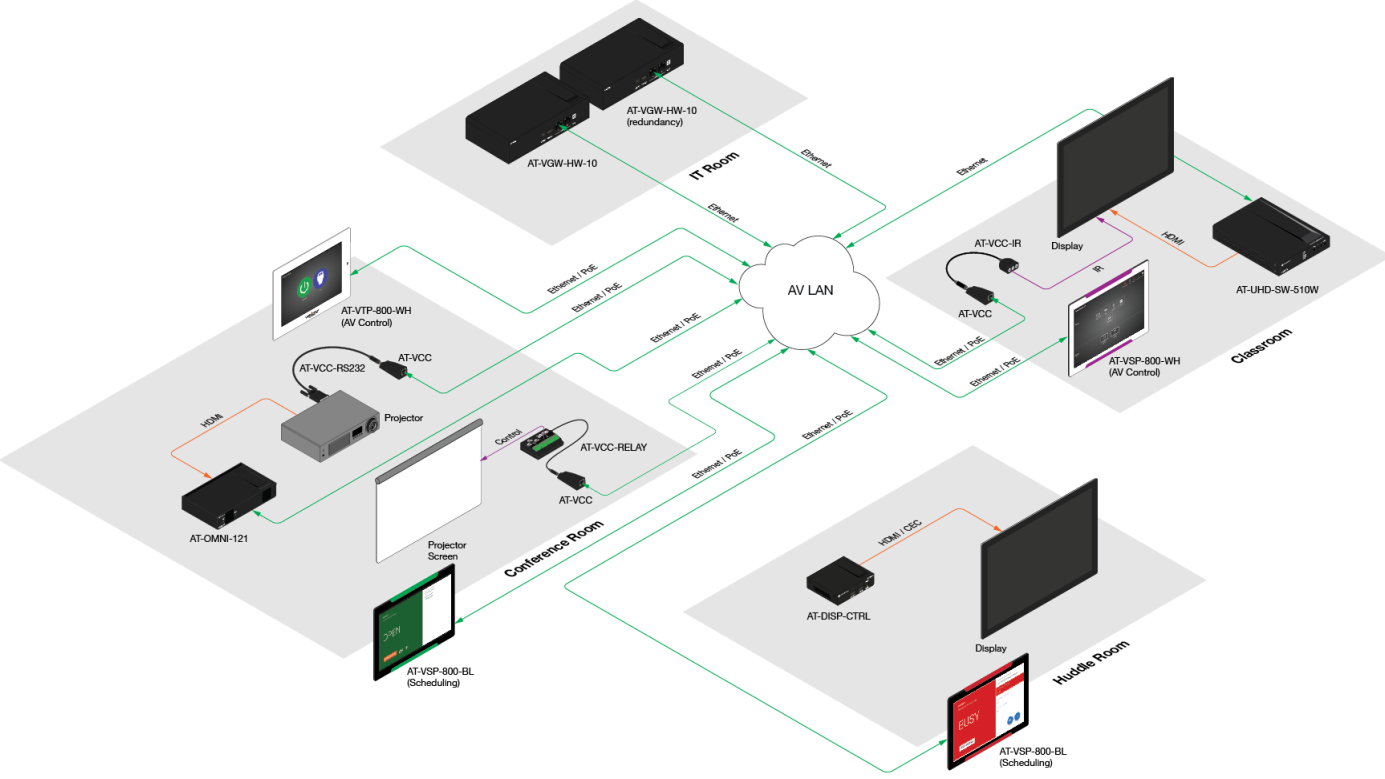

Sala de Juntas WIFI

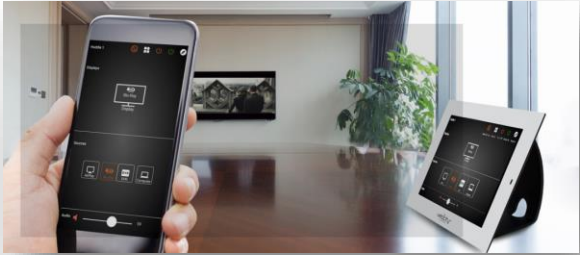

VELOCITY TOUCH PANELS & MOBILE APP TO CONTROL YOUR CLASSROOM



CASE STUDY: NORTHEAST WISCONSIN TECHNICAL COLLEGE ENHANCES ACTIVE LEARNING SPACES

Atona presentation switchers and networked AV control represent a paradigm shift in collaboration

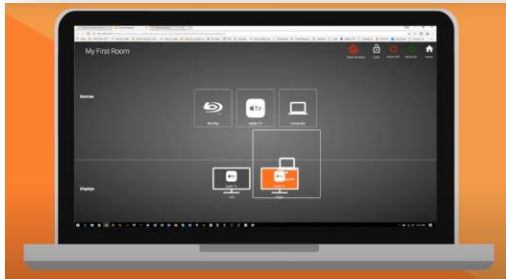

*"We now use Atona for every classroom build"
- Jonathan Tipler, Instructional Technology Technician*

VELOCITY AV CONTROL SYSTEM ELEMENTS

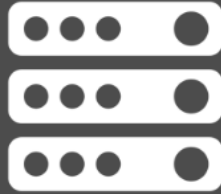

Velocity Control Gateway

A software and IP-based control processor designed for several AV systems over a network. It is available as a server appliance, or can be hosted on standard IT server infrastructure.



Velocity Touch Panels

Sleek, stylistic touch panels in 5.5" and 8" sizes with a table mount available. Velocity also offers very easy BYOD integration options for tablets, smartphones, PCs, and more.



Velocity Cloud

A centralized online resource to create and manage Velocity systems by client, client sites, and specific locations including floors and rooms. Deliver timely, premium customer service, wherever you are.

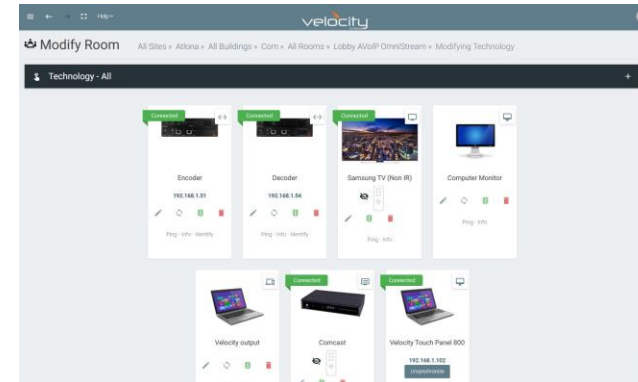

- AT-VGW-250 / AT-VTP-550 / AT-VTP-800 / AT-VSW
- Atlona Velocity™ ofrece un enfoque completamente nuevo para control Audiovisual, haciendolo mas rapido, mas facil y mas eficiente en costos que nunca, para especificar e integrar un Sistema commercial de control AV.
- Velocity cuenta con un inovador Sistema y arquitectura IP que ofrece una escalabilidad y robustez sin precedentes, ademas de un poderoso recurso en la nube para administrar multiples clientes e instalaciones en sitio.

Integracion Atlona / Symetrix



velocity[™]
by Atlona

Omnistream[™]
Pro

Omnistream[™]
Audio

NOW SHIPPING
Omnistream[™]
USB

AES67



Dante[®]



 **Symetrix**

Integracion Velocity Zoom



Reuniones Online!

- Video HD & Audio de alta calidad
- Hasta 500 participantes por Video
- Compartir pantalla y un amplio abanico de características para colaboracion
- Graba tus reuniones en la nube y genera transcripciones automaticas.

*Fusiona ZOOM con el Sistema de reunion y presentaciones Atlona y el Sistema de control Atlona Velocity para una solucion completa!



velocity™
by Atlona

zoom

Velocity 2.0

WHAT'S NEW

- License Free BYOD
- Room Scheduling
- Atlona Management System
- New Hardware Gateways
- New Software Gateway
- New Scheduling Touch Panel
- Velocity Cloud Lite
- System Redundancy

Additional information:

atlona.com/velocity

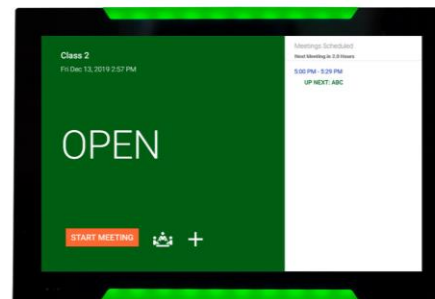
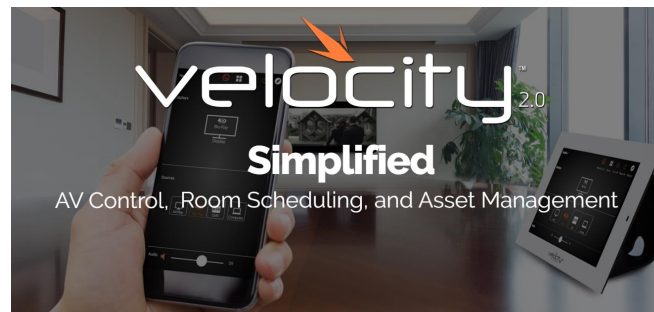

Velocity 2.0 – Gateways

AT-VGW-HW

- Hardware gateways for AV control, management, and scheduling

SKU	AV Control	Room Scheduling
AT-VGW-HW-3 – Now Shipping	Up to 3 rooms	Up to 6 rooms
AT-VGW-HW-10 – Now Shipping	Up to 10 rooms	Up to 20 rooms
AT-VGW-HW-20 – Coming Soon	Up to 20 rooms	Up to 40 rooms



AT-VGW-SW

- Software gateway, for installation on standard IT server infrastructure
- Add additional rooms with AT-VRL-SW license

SKU	AV Control	Room Scheduling
AT-VGW-SW – Now Shipping	Up to 20 rooms	Up to 40 rooms
AT-VRL-SW – Now Shipping	1 additional room	2 additional rooms

Velocity System Scheduling Touch Panel

AT-VSP-800

- 8", 1280 x 800 capacitive touch screen
- Use for room scheduling or AV control
- Bezel LED Lighting
- One-gang US, UK, or EU mounting
- PoE
- Landscape or portrait orientation
- Available in black and white

Applications:

- **Scheduling** – lobbies, hallways, meeting spaces
- **AV Control** –huddle rooms, conference rooms, classrooms, lecture halls

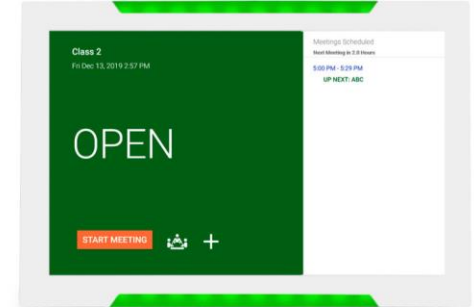
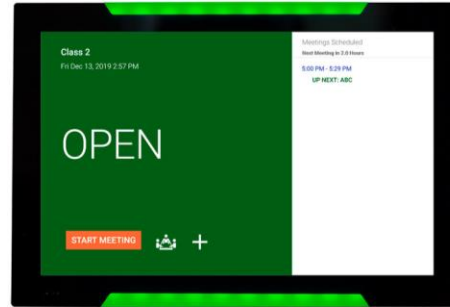

Velocity System Scheduling Touch Panel

AT-VSP-800

- 8", 1280 x 800 capacitive touch screen
- Use for room scheduling or AV control
- Bezel LED Lighting
- One-gang US, UK, or EU mounting
- PoE
- Landscape or portrait orientation
- Available in black and white

Applications:

- **Scheduling** – lobbies, hallways, meeting spaces
- **AV Control** –huddle rooms, conference rooms, classrooms, lecture halls

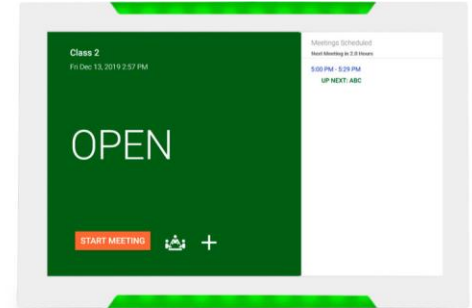
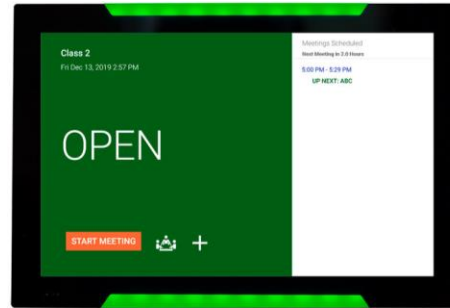

Available in mid-March

Próximo webinar – **Martes 9 de junio a las 10hrs (GMT-5)**



PANDUIT

**Sesión 13:
Soluciones de
Audio y Video
Digital con
Atlona**

Martes 9 de junio
MX - COL - ECU - PER - 10 hrs.
CL - BOL - 11 hrs.
ARG - BR - URY - 12 hrs.

**GET TO
KNOW
PANDUIT**

Conectando Empresas a un Mundo de Posibilidades

Gracias

#Panduit #acceleratethepossible

GET TO
KNOW
PANDUIT